



DARE

OPERATING MANUAL

Road Racing bike

Gravel bike

Dear Customer,

to start with, we'd like to provide you with some important information about your new bicycle. This will help you make the most of its benefits and avoid any possible risks. Please read this instruction manual carefully and keep it for your future reference.

Your bicycle has been handed over to you fully assembled and adjusted. If this is not the case, please contact your specialist retailer to ensure that this important work is completed or make sure you carefully read the enclosed assembly instructions and follow all the directions given.

It is assumed that users of this product have a basic and sufficient knowledge of how to use bicycles.

Everyone that:

- uses
- repairs or services
- cleans
- or disposes of

this bicycle has to understand and take note of the content and purpose of this operating manual. If you have any further questions or have not quite understood certain points, you should contact a specialist bicycle retailer for your own safety.

All information contained in this operating manual relates to the design, technology as well as care and maintenance of your bicycle. Please take note of this information, as much of it is relevant to safety. Failure to consider this information can cause accidents, falls and damage to property.

As modern bicycle technology is highly complex,

we have chosen to only describe the most important points.

In addition, this operating manual only applies to the bicycle with which it was supplied.

For more specific technical details, please refer to the enclosed notes and instructions from the respective manufacturers of the individual components used. If you are unsure about a particular point, please contact your specialist retailer.

Before riding your bicycle on public roads, you should inform yourself about the applicable national regulations in your specific country.

Firstly, here are a few important pointers as to the rider's person which are also very important:

- Always wear a suitable bicycle helmet adjusted to fit your head and wear it for every ride!
- Read the instructions supplied by your helmet manufacturer relating to fitting the helmet properly.
- Always wear bright clothing or sportswear with reflective elements when you ride. If you are riding in difficult terrain, please wear suitable protective clothing, e.g. body protectors. This is vital so that other people can SEE YOU.
- Always wear tight clothing on your lower body, and trouser clips if required. Your shoes should be grippy and have stiff soles.



Even if you are an experienced bicycle user, please take the time to first read the chapter "Before your first ride" and then carry out all the important checks from the chapter "Before each ride"!

Please note that as a bike rider, you are particularly at risk on public roads.

Ensure that you protect yourself and others with responsible and safe riding!

Note for parents and legal guardians:

As your child's legal guardian, you are responsible for your child's actions and safety. This includes responsibility for the technical condition of your child's bicycle and adjusting it to fit your child's body size.

Please inform yourself of what you and your child absolutely must pay attention to by reading the "Children" and "Legal regulations" sections.

In addition, you should also ensure that your child has learnt how to use the bicycle safely. The child should know how to use the bicycle properly and responsibly in the environment in which it will be used.

- Note that children under eight years of age have to ride on the pavement. Children between eight and ten years of age may use the pavement.
- Children must dismount from their bicycle when they have to cross a cycle lane.

If you leave this page unfolded when you read this guide, you can immediately recognise which part of the bicycle is being addressed.

Bicycle parts

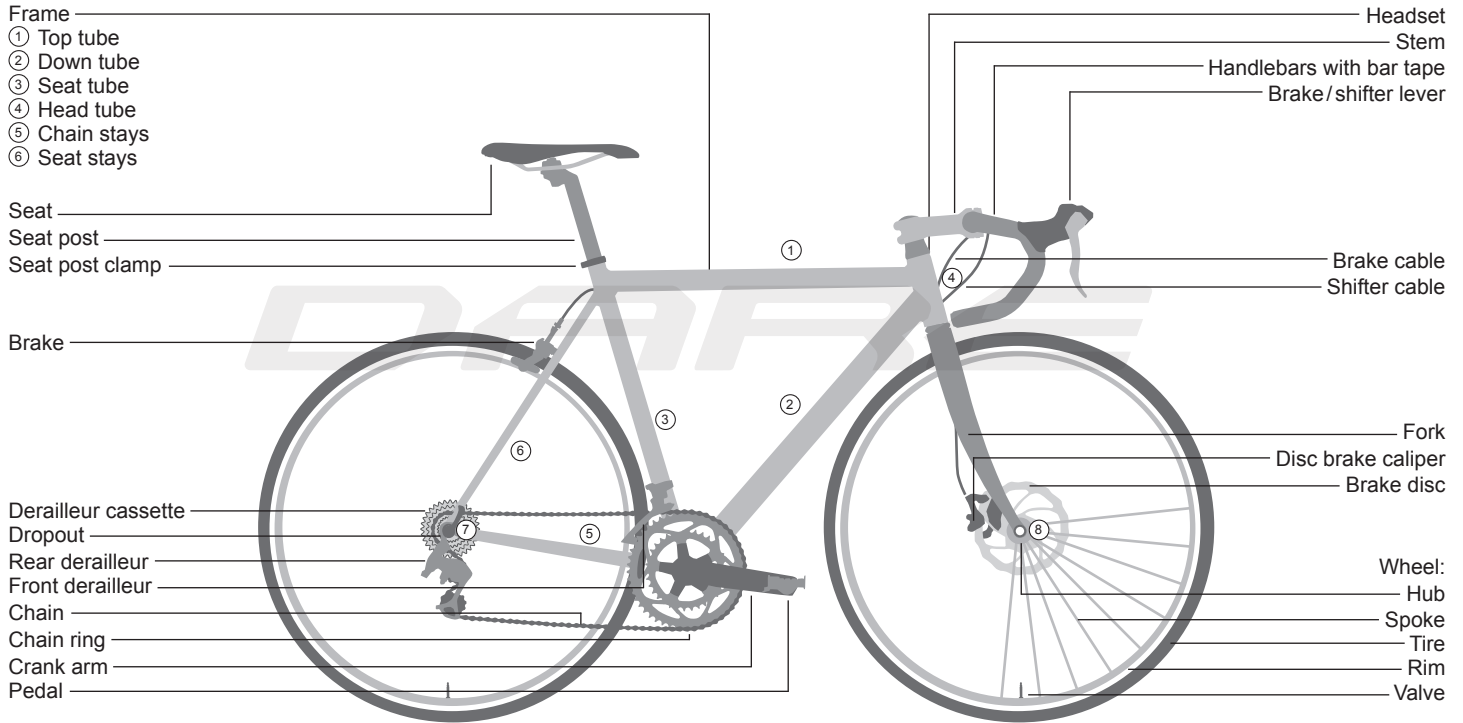

⑦ Fastening rear wheel (bolted axle/thru axle/quick release)

⑧ Fastening front wheel (bolted axle/thru axle/quick release)

Safety information

Please carefully read all warnings and notes in this operating manual before using the bicycle. We recommend keeping the manual close to your bicycle, so that it is always at hand. Before operating a pedelec for the first time, it is also highly recommended that you carefully read through the enclosed instructions about the electric motor.

Please read the sections “Intended use”, “Before the first ride” and “Before each ride” before riding your pedelec for the first time!

If you lend your bicycle to a third party, please give them this operating manual with the bicycle. This operating manual contains five different types of pointers – one providing important information about your new bicycle and how to use it, a second referring to possible damage to property and the environment, and a third type warning against potential falls and serious damage, including physical injury. The fourth type of pointer asks you to comply with the correct torque in order to prevent components from coming loose or breaking. The fifth pointer reminds you that it is necessary to study the operation and assembly manuals included carefully. If you see this symbol, there is always a risk that the danger described can occur!

The text which the warning covers always has a grey background.

Check that all quick releases are safe and secure every time you ride after your bicycle was unused, even for a short period of time! Regularly check that all bolts and components are secure. Note that components made of composite materials, i.e. carbon fibre, often require a lower tightening torque (see “Bolted connections” section, page 32). Common parts made of carbon fibre include the handlebars, stems, seat posts and saddle rails, frames, forks, and cranks. Ask your specialist retailer to instruct you on how to properly use and maintain these materials. Never ride with your hands off the handlebars. The warnings break down as follows:



Information: This symbol provides information about how to use the product or highlights specific parts of the operating manual that are particularly important.



Warning: This symbol is aimed at warning you against improper use that could result in damage to property or the environment.



Danger: This symbol indicates possible dangers to your health and life that could arise if specific actions are not taken or corresponding regulations adhered to.



Important bolted connection: Please adhere to the exact recommended torque when tightening this connection. The correct mounting torque is either displayed on the component or listed in the table of torques in the “Bolted connections” section (page 32). A torque wrench has to be used to achieve the precise prescribed torque. If you don't own a torque wrench then you should always leave this work up to a specialist retailer! Parts which do not have the correct torque could fall off or break! This can result in serious accidents!



Read all of the instruction manuals delivered with the vehicle. If you are unsure about any of the topics addressed in this handbook, contact your specialist dealer.



The illustration shows road racing bike as typically sold commercially. The bike you purchased may look somewhat different. This manual describes bicycles in the following categories: Road Racing bike, Triathlon/Time trial bike, Cyclocross bike, Gravel bike, Single-speed bike/Fixe. This instruction manual only applies to the bicycle mentioned on the envelope with which it was issued.

Contents

Introduction	A	Maintenance / upkeep	17
Bicycle parts	B	Chain	18
Safety information	C	Wheels	19
Imprint	1	Tires and tire pressure	21
For your safety	2	Flat tire repair for conventional tires	22
Before the first ride	2	Brakes	24
Before each ride	4	Gears	27
If you have had a fall	4	Triathlon/TT bike	29
Legal regulations	5	Inspection plan	30
Intended use	5	Lubrication	32
Adjusting the bicycle to the rider	7	Bolted connections	33
Using quick releases and through axles	7	Loose accessories	34
Through axles	8	Loose luggage rack	34
Installing pedals	9	Mudguards	35
Setting up the seating position	10	Trailers	35
Setting up the angle of the seat	10	How to use carbon components	36
Setting up the position of the handlebars / stem	11	Transporting the bicycle	37
Setting up the brake levers	12	Warranty and liability in the case of defects	38
Children	12	Environmental protection tips	38
Important notes for parents	12	Inspections	39
Frame	16	Hand-over documentation	D
		Bicycle identification	E
		Notes / Guarantees	F

Imprint

For questions concerning your bicycle please always contact your dealer first, only then in case the manufacturer of the bicycle.

For contact details please refer to the warranty section, back cover or other included information of the brand/manufacturer.

Responsible for sales and marketing
inMotion mar.com
info@inmotionmar.com
www.inmotionmar.com

Content and images

Veidt-Anleitungen
info@veidt-anleitungen.de

Legal inspection by a lawyer's office specialising in intellectual property

These operating instructions cover the requirements and scope of EU law.

In the case of delivery or use of this product outside of the scope of the aforementioned area, the manufacturer of the bicycle is required to supply the necessary operating instructions.

© Multiplication, reprinting and translation as well as any commercial use (including extracts, in printed or digital form) is only permitted if specifically granted in writing in advance.

RR EN Edition 2.1, November 2024

For your safety

These instructions assume that you can already ride a bicycle. It is not a teaching manual to help you learn to ride. Nor is it meant to provide you with information on setting up or repairing the bike. Always be aware that there are basic risks involved in cycling. As a cyclist you are particularly exposed to risk. Always be aware that you do not have the same level of protection as you have in a car, for example. You have neither airbags nor bodywork around you. However you are travelling more quickly and in other areas of the road than a pedestrian. Accordingly, you should pay particular attention to other road users.

When cycling, never wear headphones or use a mobile telephone. Never cycle if you are not in a condition to be in complete control of your bicycle. This applies particularly if you have taken medicines, alcohol or other drugs.

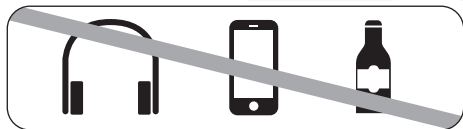

- If the road surface is wet or slippery, adjust your cycling style accordingly. Cycle more slowly and brake carefully and early, as your stopping distance is significantly increased.
- Adjust your speed in accordance with the terrain and your cycling ability.



- **INGESTION HAZARD: DEATH** or serious injury can occur if ingested.
- A swallowed button cell or coin battery can cause **Internal Chemical Burns** in as little as **2 hours**.
- **KEEP** new and used batteries **OUT OF REACH OF CHILDREN**
- **Seek immediate medical attention** if a battery is suspected to be swallowed or inserted inside any part of the body.

Before the first ride

Please also consult the additional operating manuals of the individual component manufacturers, which were supplied with your bicycle or available online.

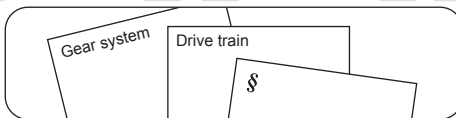

Your specialist bicycle retailer will be happy to answer any further questions you have after reading this manual.

Please ensure that your bicycle is ready for use and is adjusted to fit your body.

That means:

- Setting the position and fixture of the seat and handlebars
- Checking the assembly and settings of the brakes
- Securing the wheels into the frame and fork

To ensure that you enjoy a safe and comfortable riding position, please allow your specialist retailer to set up your handlebars and stem.

Adjust the seat to a safe and comfortable position for you (see page 10). Allow your specialist retailer to set up the brakes so that the brake levers are always within easy reach. Ensure that you know which lever operates which brake (right/left)! Usually, the right brake lever operates the rear wheel brake and the left brake lever operates the front wheel brake. Despite this, however, you should still check if the same rule applies to your bike's levers before riding it for the first time, as this can sometimes vary.



Modern braking systems might be more powerful or have a different functionality than those that you are used to. Please familiarise yourself with the brakes on a safe piece of land before setting off on your first ride with the bicycle!

If you use a bicycle with carbon fibre rims, please note that this material provides a significantly worse braking effect in combination with rim brakes than aluminium rims do! Also remember that the effectiveness of brakes can be different, often worse, than you are used to in wet conditions or on slippery surfaces. Please take the possibility of longer braking distances and slippery surfaces into account when riding!

If you are riding a single speed or a "fixie", please familiarise yourself with its behaviour under braking before your first ride! Sin-

gle speed wheels with just one brake are not permitted on public roads. Fixed-gear bikes do not have a freewheel mechanism. The cranks always turn whenever the back wheel is turning.



If your bicycle has rubber or plastic cage pedals, please familiarise yourself with the grip which these offer. In wet conditions, rubber and plastic pedals can be very slippery!

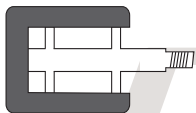

Snagging hazard

Moving and turning parts of your bike may lead to danger during use, maintenance and upkeep.

Protect yourself by not wearing loose clothes that may get caught. During use, maintenance and upkeep, stay away from turning parts (wheels, brake discs, cassettes). Do not touch moving, sharp or protruding parts (chains, pedals).

Ensure that the wheels are securely fastened in the frame and fork. Check that all quick release skewers, through axles and all important nuts and bolts are secure (see page 7 and 33).

Lift your bicycle up slightly and drop it onto the ground from about 10 cm in the air. If it rattles or makes another unusual noise, ask a specialist retailer to identify and fix the problem before you ride.

Push the wheels forwards with the brakes applied. The back brake should completely prevent the back wheel from moving, while the front brake should lift the back wheel off the ground with its braking effect. Please take an initial test ride in a safe place where you can familiarise yourself with the new brakes! Modern brakes can behave completely differently under braking than those that you are perhaps used to. The bicycle's steering should not rattle under braking or exhibit any play.

Check the air pressure in the tires. You will find instructions as to the correct tire pressures on the sides of the tires. Please adhere to the required minimum and maximum pressure! Where no pressure values have been stated, 6.5 bar / 94 PSI are deemed to be a suitable pressure for racing bicycles. Cyclocrosser tires may be pumped up to 3–4 bar / 43.5–58 PSI.

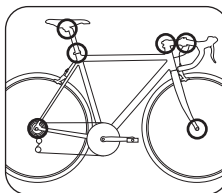

Possible positions of quick release skewers, through axles and screw connections

As a general rule of thumb when you are out on a ride, you can check the tire pressure by doing the following: If you place your thumb on a pumped up tire, you should not be able to significantly change its shape by applying pressure.

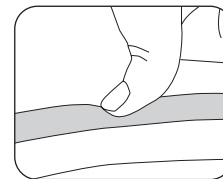

Check the tires and rims. Scan them for any damage, cracks or deformations, as well as embedded particles, e.g. shards of glass or sharp stones.

If you should find any cuts, rips or holes, please refrain from riding! First have your bicycle checked over by a specialist.

Before each ride

Before every ride, please check that:

- The lights and bell are working and safely secured
- The brakes are working safely and are properly secured
- The cables and fittings are not leaking if you have a model with hydraulic brakes
- The tires are free of foreign objects and damage, and the rims are not damaged and run true, particularly after riding off road
- The tires have a sufficient tread depth
- All bolts, nuts, through axles and quick releases are tight (see pages 7 and 33)
- There are no deformations or cracks on the frame and fork.
- The handlebars, stem, seat post and seat are both correctly and securely fastened as well as set up in the right position
- The seat post and seat are secure. Try turning the seat or tipping it upwards or downwards. It should not move.
- If you are using clipless/magnet pedals, please check that they are working properly. The pedals should release easily and smoothly.



If you are unsure of whether your bicycle is in a sound technical condition, take it to a specialist retailer to be checked instead of riding it! It is particularly important if you use your bicycle a lot, either through sports riding or daily use, that you regularly have all the im-

portant parts checked by a specialist retailer. Frame and fork, suspension components and other parts relevant to your safety such as brakes and wheels are subject to heavy wear, which can impact the operating safety of these parts.

If you use parts for longer than their intended lifetime, these can fail without warning, which can in turn lead to falls and serious injury!



Please make these checks before continuing after a fall or if your bicycle falls over!

Aluminium parts cannot be safely bent back into shape, while carbon components can sustain damage which is not recognisable to the eye.

Allow the bike to be checked by a specialist retailer.

If you have had a fall

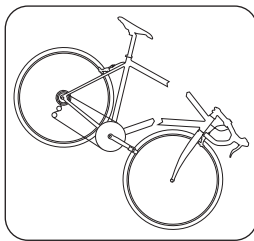

Check out the entire bicycle for any changes. These might be dents and cracks in the frame and forks, or bent components. And if parts like the handlebars or saddle have been

displaced or twisted, you must check that these parts are properly seated and functioning.

- Take a close look at both frame and forks. If you inspect the surface from a variety of angles, in most cases any deformations will become clear.
- Ensure that the saddle, seat tube, stem and handlebars are still in the correct position. If they are not, DO NOT bend the component back out of its changed position without slackening off the relevant threaded connection. When tightening components it is essential that you observe the stipulated tightening torque. You will find the relevant values on page 33 and in the section "Using Quick releases", page 7.
- Check that both wheels are properly and securely aligned within the frame and forks. Lift the bicycle at both front and rear and spin the relevant wheel to check. The rim must run straight through between the brakes without any contact. The tires must not touch the brakes. For bicycles with disc brakes, inspect the gap between the frame or forks and tires to ensure that the wheel is not buckled.
- Check that both brakes are operating fully.
- Do not set off again without having checked that the chain is sitting securely on both the front chain wheel and rear sprockets. It must be engaged fully with the cogs. If you set off and the chain jumps off a cog you may fall, at the risk of very severe injury..



Aluminium components are prone to breaking without warning if they have been deformed. Never use any components which have been deformed

or bent after a fall, for example. Always replace such components.

Carbon components can be seriously damaged without displaying any visible evidence of this. After a fall, have all carbon components checked out by your specialist dealer.

If you notice any change in your bicycle, DO NOT continue cycling. Do not retighten any loose parts without first checking them and always use a torque wrench. Take the bicycle to your specialist dealer, describe the fall to him and have the bicycle checked out!

Legal regulations

Before riding your bicycle on public roads, you should inform yourself about the applicable national regulations in your specific country.

This section provides information on how the bicycle has to be equipped to be permitted to participate in public road traffic.

Here you can find out which light systems have to be installed or carried with you and which brakes the bicycle has to be equipped with.

There is also an explanation of which age restrictions apply and what age riders have to be to ride where. The participation of children in public road traffic is also addressed here. If there is an obligation to wear a helmet, it is stated here.



Intended use



Bicycles are intended for transporting one person at a time. If you are planning to transport additional people, you should inform yourself about the applicable national regulations in your specific country. A tandem is exempt from this. If you would like to transport baggage, this requires that your bicycle is fitted with suitable equipment. Children can only be transported in children's seats or trailers intended for this purpose. We recommend not taking any chances when it comes to quality in this area! Ensure that you do not exceed the maximum permissible weight.



Maximum permissible weight:

Rider's weight + Bicycle weight + Baggage weight (see page D)

The information provided in this operating manual only applies to the types of bicycles listed on the cover. Information on individual models is labelled accordingly. Using the bicycle as intended also means adhering to the operating, maintenance and upkeep conditions described in this manual.



Dangers of improper use

Only use your bike for its intended use. Read the section "Intended Use".

This also includes adherence to the operating, servicing and maintenance conditions that are described in this manual.

Inform other users of the intended use and the dangers of not adhering to it.

Improper use, overloading and lack of maintenance may lead to accidents and falls involving severe injuries to you and other people!

The components have been solely designed and approved for use in bicycles without electrical assistance. They should not be used for any other purpose. They can only be used in competitions or for commercial purposes with the express permission of the manufacturer.



Example sticker

There may be a sticker on your bicycle that shows you what you can use your bicycle for.

Your bicycle must be equipped in accordance with the applicable national regulations in order for it to be used in the way indicated by this sticker.

Always read and comply with the conditions of use for your bicycle type:



Type 1 includes city and touring bicycles and can be used on normal and paved surfaces. The typical speed should be between 15 and 25km/h. The tires should stay in contact with the ground at all times. They can occasionally be used to ride up and down small drops of 15cm max.

(e.g. curbs) as long as this is done carefully.

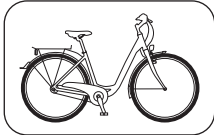

These bicycles are intended for use for commuting and recreational rides with moderate exertion.

Manufacturers and dealers are not liable for any use outside of the conditions of use for Type 1 bicycles. This particularly applies to damage resulting from a failure to comply with the safety instructions, such as:

- off-road use;
- improper use;
- overloading;
- the improper repair of defects.

Type 1 bicycles are not designed to withstand extreme use, i.e. riding down stairs or on jumps, performing tricks/stunts or racing in official competitions. Participation in competitions is only allowed when authorised by the manufacturer.

Type 2 includes ATBs, trekking, cyclo-cross and gravel bicycles.



The conditions of use for type 1 bicycles apply. In addition, these bicycles can be used on unpaved or gravel roads. They can also be used on routes with moderate elevations and gradients. The typical speed should be between 15 and 25km/h. The tires may repeatedly lose contact with the ground

when riding on uneven terrain. They can be used for drops or jumps up to 15cm high.

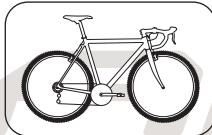

These bicycles are designed for recreational rides and trekking under moderate strain.

Manufacturers and dealers are not liable for any use outside of the conditions of use for type 2 bicycles. This particularly applies to damage resulting from a failure to comply with the safety instructions, such as:

- off-road use;
- improper use;
- overloading;
- the improper repair of defects.

Type 2 bicycles are not designed to withstand extreme use, i.e. riding down stairs or on jumps, performing tricks/stunts or racing in official competitions. Participation in competitions is only allowed when authorised by the manufacturer.

Type 6 includes racing, triathlon and TT bicycles.



The conditions of use for type 1 bicycles apply. In addition, their typical speed is between 30 and 55km/h. In competitions or on other occasions, top speeds of over 50km/h may be reached, e.g. during sprints or descents.

These bicycles are designed for use in sporting and competitive events with high exertion.

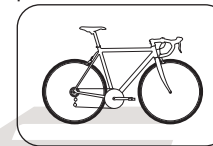

The conditions of use described require the rider to have sufficient expertise and technical skills.

Manufacturers and dealers are not liable for any use outside of the conditions of use for type 6 bicycles. This particularly applies to damage resulting from a failure to comply with the safety instructions, such as:

- off-road use;
- improper use;
- overloading;
- the improper repair of defects.

Type 6 bicycles are not designed for extreme strain, such as riding down stairs or on jumps or performing tricks or stunts.



If you are not sure what type of bicycle you have, ask your specialist bicycle retailer or the manufacturer about its intended uses. Before riding your bicycle on public roads, familiarise yourself with the regulations that are applicable in your country. Only ride on routes where vehicles are permitted. Specific national or regional regulations may apply.

Adjusting the bicycle to the rider

The seat post, seat, stem and handlebars can be fastened with quick releases or bolted connections.



Please ensure that you read the manufacturer's operating manual for your stem. Only allow specialists to work on your handlebars and stem!

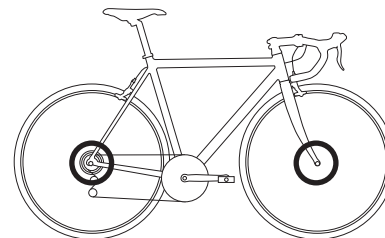

Possible positions of quick releases/through axles

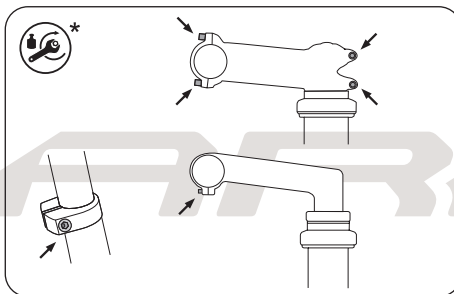

Possible positions for adjusting bolted connections

Using quick releases and through axles

Quick releases and through axles are systems installed on the bicycle in place of bolted connections. They consist of two parts: the clamping lever, which provides the necessary clamping force, and the locking nut, which allows you to regulate the clamping force. You can change the setup of your quick release when the clamping lever is open.



A good gauge for measuring if the wheel is safely clamped is if you can only close the clamping lever with the balls of your hands when the resistance increases after closing the lever about half way.

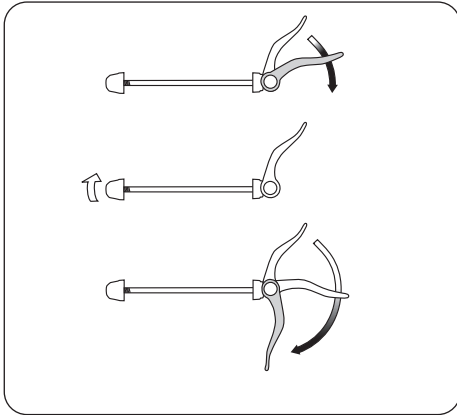

Loosening adjusting nuts

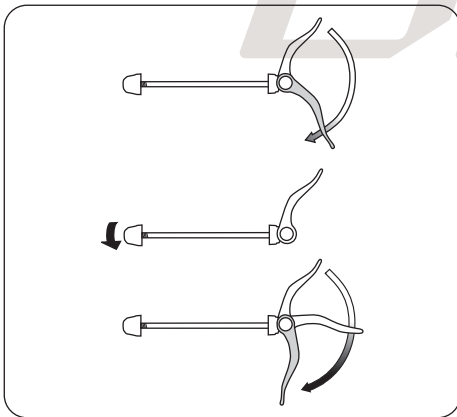

Tightening adjusting nuts



- Check that all quick releases are properly fastened before every ride.
- Make sure that all quick releases and through axles are properly in place even if the bike was only left unattended for a short period of time.
- When it is closed, the quick release lever should be flat against the frame, fork or seat post!
- When it is closed, the end of the quick release lever should always point backwards. This ensures that it cannot be opened through contact during riding.
- The quick release lever for the wheel has to be installed on the opposite side to the brake disk, otherwise you could suffer burns from the brake disk. The clamping force of the quick release can also be reduced if it is heated by the brake disk.



If your bicycle has quick-release skewers or other components, ensure they are engaged when you park the bicycle.

Through axles



If your bicycle has one or several through axles, please read the corresponding instructions provided by the component manufacturer on how to operate and service these parts.

Through axles that mostly function – and must be handled – like quick releases, are also currently used in chassis in lieu of bolts.

The axle is screwed into the drop-out and secures the hub between the two fork arms or the drop-outs in the frame. With some systems, the hub and axle are secured with a quick release lever operated in the same way as a normal quick release skewer. Systems in which the axle is only inserted or screwed in and then fastened with a screw also exist.

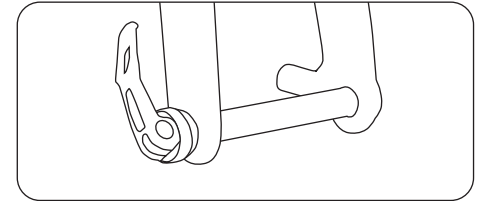

Refer to the attached component manufacturer instructions and allow your dealer to explain the system to you in detail.



Inappropriately installed wheels may shift while you are driving or detach from the vehicle. This may damage the vehicle and expose the driver to severe and life-threatening injuries. It is therefore important to take note of the following instructions:

- Ensure that your axle, drop-outs and through axle mechanisms are free from dirt and contamination.
- Ask your dealer for exact instructions on the proper way to secure your wheel in the through axle system on your bicycle.
- Fasten your wheel appropriately with the through axle.
- Never use the bicycle unless you are sure that the wheel has been properly secured and cannot come loose.

Mounting

Place the wheel in the dropouts. The wheel hub must be fastened securely in the dropouts. Close the fixing mechanism.

Ensure that the brake disk is properly inserted into the brake calliper. Ensure that neither the brake disk nor the hub or the brake disk fastening screws touch the lower parts of the fork.



If you do not know how to adjust the disk brakes of your bike, please read the instructions provided by your disk manufacturer.

Installing pedals

If your bicycle was supplied without the pedals pre-installed, these have to be attached with the correct wrench. Please note that the pedals have to be screwed in in different directions and secured with a high mounting torque (see page 33). Apply assembly grease to both threads.

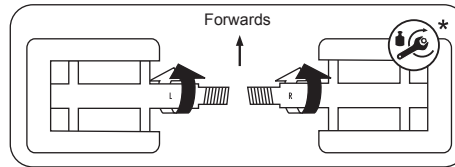

Please read the enclosed instructions from the respective manufacturer if you use pedals that feature hook or strap systems. Practice taking your feet in and out of the hooks and operating the strap releases in a safe place. Tightened straps do NOT release the feet! Possible consequences are falling and injuries.

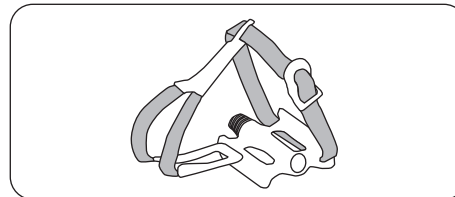

Ensure that you read the manufacturer's instructions before using magnet or clipless pedals. Practice clipping your shoes in and out of the pedals' locking system before your first ride in a quiet, safe place. Clipless pedals which do not properly release are a safety hazard.

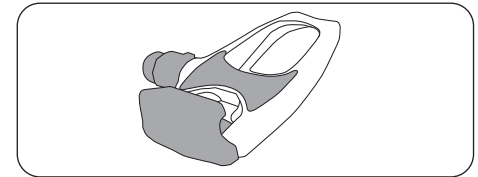

In the case of magnet pedals, you are able to adjust how much force is required to release the shoe from the pedal. Please test this on your first ride with a setting that releases very easily! Regularly clean your magnet pedals and keep them in good condition with a suitable spray lubricant.

* see page 33

Setting up the seating position

Before you use your bicycle for the first time, the seating position has to be set up to suit your body size. This is vital for riding safely and securely. To do this, the seat's height, alignment and angle have to be set up, as do the height and alignment of the handlebars with the stem.

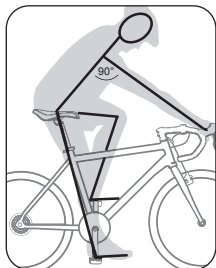

Correct seat height

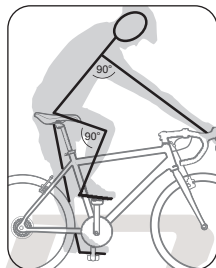

Knee joint of the upper leg at min. 90°, angle of arm 90°

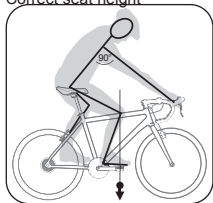

The knee should be above the axle of the front pedal

Determining the correct seat height

Set the saddle to what you think is the right height. Sit on the bicycle. Enlist the help of another person or support yourself against a wall or a railing.

Bring one pedal down to its lowest position and place your heel on it. Your leg should now be fully stretched.

If you place your foot in its proper position for cycling, your leg should now be lightly bent.

Your foot is in the right position for cycling when its widest part is right above the pedal spindle.

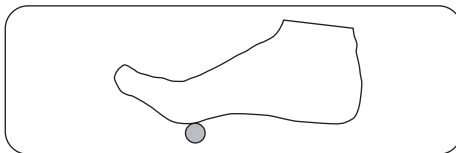

If you are using clipless pedals, the pedal cleats should be adjusted so as to ensure your foot is in this position. This prevents damage to your musculoskeletal system and ensures the best possible delivery of power.



Children and people who are not confident cyclists should be able to touch the ground with the tips of both feet. Otherwise, when stopping they run the risk of falling and suffering serious injury.

The minimum saddle height should be adjusted to the body of the rider. The rider must be able to cycle freely without hindrance to their health or safety.

The seat post should always remain securely clamped into place by the bolt.

Setting up the angle of the seat

When you have set the height of the seat, you have to check that the angle of the seat is suitable. The surface of the saddle should always be approximately parallel to the ground. You can adjust this by loosening the clamping bolts in the seat post.

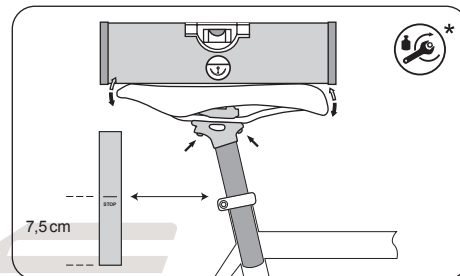

Patented seat post with two-screw locking mechanism

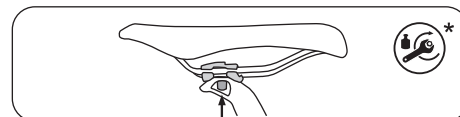

Patented seat post with one-screw locking mechanism

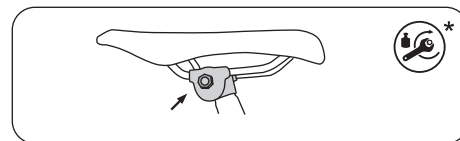

Attachment with seat clamp

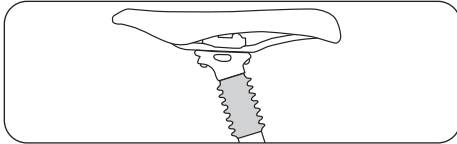

Suspension seat post

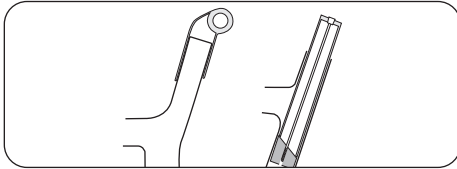

Integrated Seatpost

If your bicycle is equipped with a so-called integrated seatpost or a seatpost with integrated fixture for operation and adjustment please read the enclosed instructions from the respective manufacturer.



Before you start riding, please test to see if your seat post and seat are secure. To do this, grab the seat at the front and back and attempt to turn it. It should not move.



When adjusting the height of the seat, never pull the seat post further out than the maximum extension length marked! If your tube does not have a maximum marking, then you must leave a minimum insertion length of 7.5 cm.

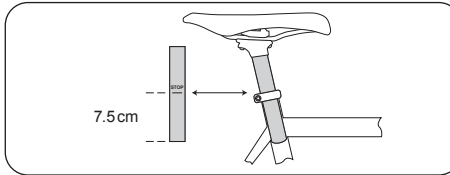

Setting up the position of the handlebars / stem



For detailed information about your stem, please read the operating instructions supplied by the manufacturer.



Only allow specialists to work on your handlebars and stem.

Various types of stem are used on bicycles:

Quill stem

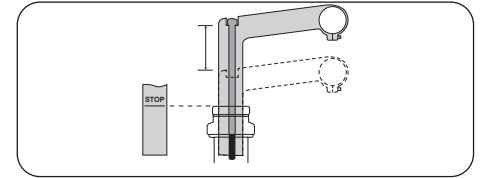

Height adjustment possible



Changing the position of the stem also changes the position of the handlebars. You should always be able to safely reach and use grips and controls. Please ensure that all cables and lines are long enough to allow you to turn the handlebars in every possible way.

Threadless stem

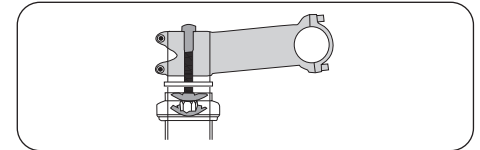

Height change possible as follows:

- Exchange of fitted spacers under or above the stem
- Turning of the stem
- Exchange of the stem

Adjustable stem

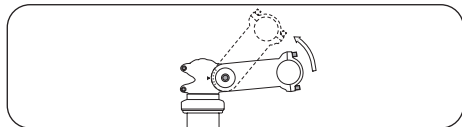

Adjustment of stem tilt possible



Please ensure that you read the manufacturer's operating manual for your stem. Only allow specialists to work on your handlebars and stem, do not attempt to do this yourself!

Setting up the brake levers

Set up your brake levels in such a way that you can safely apply them and brake comfortably. Please familiarise yourself with which lever operates which brake!

Some brakes are now equipped with power modulators. This guards against "overbraking" and any dangerous locking of the wheels.



When using power modulators, the braking force can increase sharply if you squeeze the brake levers hard or all the way to the end of their leverage. Please familiarise yourself with this new braking behaviour. Ensure that you receive and read the manufacturer's operating manual.



Check the position of the brake levers before your first ride.

In derailleur gear systems, the left brake lever on the handlebars generally operates the front wheel brake.

If you would like to swap the position of the brake levers on the handlebars, please contact a specialist retailer to do the work.

In order to allow people with smaller hands to safely apply the brakes, the levers can be set up to be closer to the handlebars using an adjusting screw (located in the lever). Please read the enclosed instructions from the respective manufacturer.

Set up the cable tension in such a way that the brake levers do not touch the handlebar grip, even when they are applied to their fullest extent!

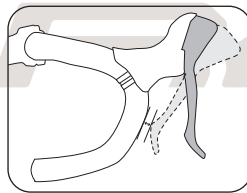

Children

Important notes for parents

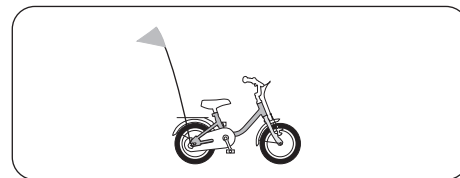

Before your child uses the bicycle alone, spend some time with them while they learn to cycle. Discuss and practise controlling the bike and talk to them about appropriate behaviour in traffic.

It is especially important to supervise them carefully on their first bike rides. Whatever you do, while practising with your child, take care not to push them out of their comfort zone too quickly. Before they set off on a bike ride, make sure they are familiar with the use and feel of the brakes, especially if the bike is fitted with back pedal brakes.

Choose a suitable area, such as a safe street or square without traffic, to help your child learn to cycle and use their bicycle.

Teach them how to tackle obstacles such as low kerbs and tram tracks to prepare them for cycling on a public road. They should learn to ride over such obstacles at as large an angle as possible and make sure that there is no danger to their front or rear.

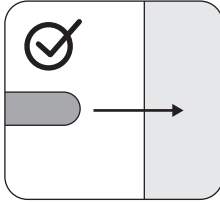
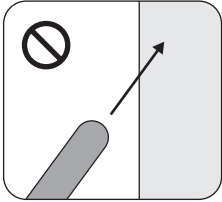

Never let your child ride without a helmet!

Only buy certified cycle helmets.

Take your child with you when purchasing the helmet so they can try it on and choose one that fits and that they like. They will be more likely to accept and wear a helmet that appeals to them.

Make sure the helmet fits perfectly and that the straps are properly adjusted and attached.

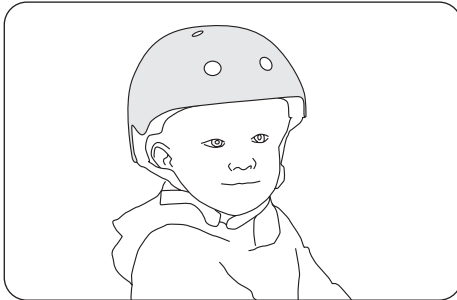

Make sure the child wears bright clothing, tight-fitting trousers, and shoes with firm non-slip soles. Reflective strips are recommended for visibility.

Contact a specialist dealer if you have any questions about the maintenance and use of your bike.

Stay informed about applicable national traffic regulations. In Germany, for example, children may only cycle on pavements or footpaths until they have reached 8 years of age. They may cycle on footpaths until they reach 10 years of age. Children's bikes are usually not built according to legislative standards, and for this reason must not be ridden on public roads.

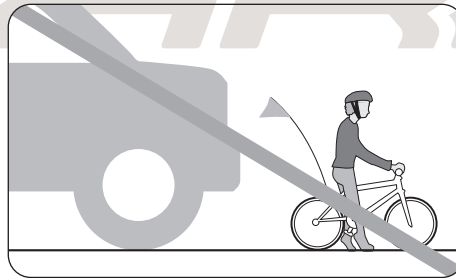

Before the first ride

- Familiarise your child with the brake system. Supervise them while they have a few goes at using the brakes.
- Make sure they understand that the brakes don't work as well in wet conditions, and that they should cycle more slowly on rainy days.



Make these first cycling lessons into a game so that they are fun for your child - this will help them learn faster and enjoy it more!

Before each ride

Go through the checks and tests laid out in this chapter regularly with your child. This way they will learn how to take care of their bike and will know how to recognise malfunctions and tell you about them.

Repair any defects immediately or take the bicycle to a repair shop.



If you notice any problems while checking the bike, do not let your child ride the bike. This could lead to a serious accident. If in doubt, contact a specialist dealer.

Adjusting the bicycle to the child

When adjusting the saddle height, make sure your child can cycle with ease while also being able to touch the ground with the balls of their feet. This is important to that they can hold themselves upright if they need to stop or do not feel safe cycling.

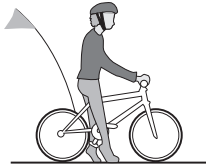

Remember to check the saddle height every three months for children and teenagers.

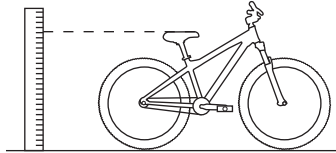

Service/Maintenance

Check your child's bike regularly. Young children especially cannot be relied on to monitor the bike's safe operation.

Operating the brakes

Familiarise your child with the use of the brakes in a safe area. They should learn how to operate both brakes at once: if they only use the front brake, their weight could shift, causing them to flip over the handlebars.



Familiarise your child with which way round the brake levers work. Which lever is linked to which brake can vary between bikes. If necessary, ask a specialist to switch the brakes over.



Ask your child to be careful when learning to use the brakes. They should only practise emergency braking on even ground without traffic.



If the roads are wet and slippery, your child should be especially careful while braking as the tires can slip off course. Tell them to ride their bike more slowly whenever the weather is bad.

Tires



Ask your child not to ride over high curbs or steps, as doing this could damage the wheels or tires of the bike or even cause a fall.

Children's Bicycle/Stabilisers

As a parent or legal guardian, you have a major responsibility when your child rides a bicycle and wants to ride on public roads!

- Take the time to accompany a child on their first ride in a safe and quiet place (car park, field).
- Explain to the child that they should only ride the bike wearing a helmet and easily visible, bright clothing.
- Set up the seat and handlebars so that the child is able to touch the ground with their feet in unsafe situations; it is important for them to have a relaxed seated position to control the bicycle safely.
- Explain how to use the front and rear brakes and practise. It is especially important to know how to use back pedal brakes while carefully pressing the handbrake to slow down the front wheel.



If you are using stabilisers, please make sure that you carefully read the manufacturer's assembly instructions. The stabilisers have to be absolutely secure, as your child is relying on their support. If you are not sure whether you have correctly assembled the stabilisers, please ask a specialist retailer for advice.



Stabilisers should only be used to assist the youngest children who starting to learn to cycle. We recommend you remove them as early as possible to help your child train their sense of balance.



Using stabilisers can help a child get used to riding a bicycle. It avoids falls and helps children to feel safer. However, they quickly get used to riding with this "tricycle"-style bike. They have no opportunity to learn to keep their balance and shift their weight to stay upright and steer. This is why you have to be particularly careful when you first remove stabilisers. It feels unfamiliar to the child, who has to relearn how to cycle.

Kickstand

Make sure that your child lifts up the kickstand before cycling away in order to avoid accidents.

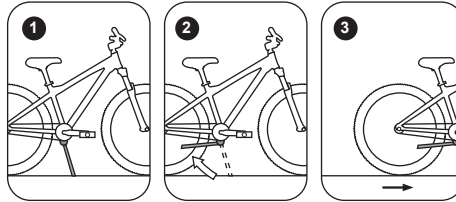

Carrying Children/Trailers for Children

- Please only use safe, certified children's seats.
- The child must wear a helmet, their feet must be tucked in and protected from any possible contact with moving parts, such as spokes.
- A child seat changes the way your bicycle behaves when riding. Take note of the longer braking distances and the more unstable steering. Practice riding with a child seat in a safe area before taking to public roads.



Please comply with the manufacturer's instructions supplied with the seat.



Only install children's seats on bicycles which are suitable for this kind of equipment.

Carbon fibre frames and components are not suitable for the use of children's seats. Never attach a children's seat to the seat post. Wrap and protect all springs and moving parts on the saddle and seat post. Please ensure that your child cannot trap their fingers anywhere. This could result in injury!

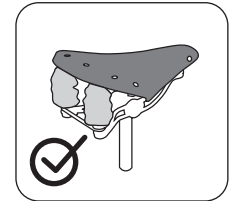
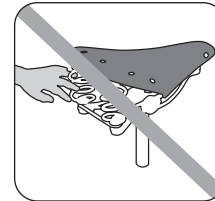
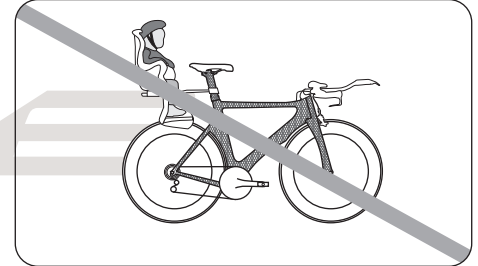



If additional equipment was delivered with your bicycle which was not pre-assembled, please ensure that you read the manufacturer's instructions.

Child bike trailers:

- Take no chances in terms of quality when buying bike trailers for children.
- Only install child bike trailers on bicycles intended for this purpose using mounting parts which are supplied or approved by the manufacturer.
- It is easy not to see a child bike trailer in traffic! Use a brightly coloured flag and approved light system to ensure that it is easily seen. Ask a specialist retailer about safety equipment.



Notice that trailers make the bike's length much longer than usual. A trailer for children changes the way your bicycle behaves when riding. Take note of the longer braking distances and the more unstable steering. Riding a bike around corners with a trailer is different to riding without. You must keep this in mind when riding in traffic. Before riding on public roads, practise riding your bike with an empty trailer in a safe and quiet environment.

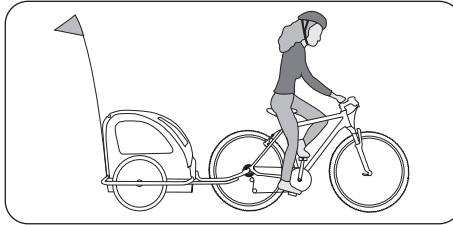

Only install child bike trailers on bicycles intended for this purpose using mounting parts which are supplied or approved by the manufacturer.



Check whether the manufacturer provides a maximum permitted weight and a maximum permitted speed. If so, these values must be adhered to. Children under 16 are not legally permitted to ride a bike with a trailer in Germany.

Frame

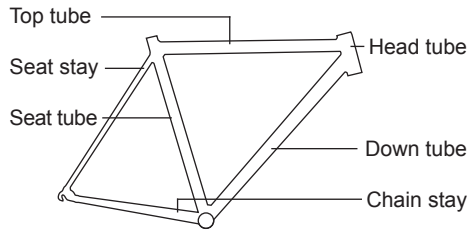

Frame shapes vary according to the type and function of the bike. Modern frames are made of various materials, such as steel, aluminium alloys or carbon (carbon fibre).

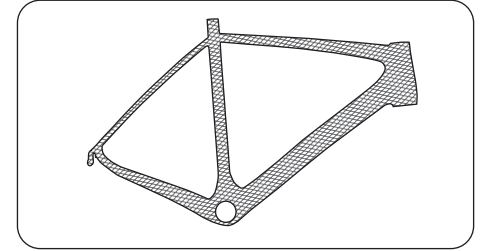

Carbon frame

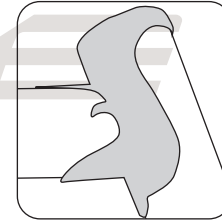

Lugged steel frame

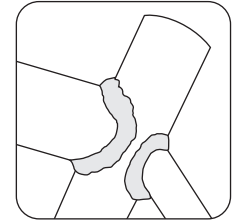

Welded aluminium frame

Thanks to the evolution in materials and construction techniques, nowadays it is possible to produce all shapes of frames safely so they perform stably during riding. So despite a low stepthrough, you can still be sure that your bicycle is always safe on the roads, even with luggage on board.



If your bicycle is stolen, it can be identified using its frame number. Please always note down the full number in the correct order. Otherwise it is impossible to make a unique identification. In the documentation you received from the retailer when you purchased your bicycle, there is also a section where the frame number is entered.

The frame number can also be engraved on various parts of the frame. It is frequently found on the seat tube, at the drop-outs or on the bottom bracket casing.

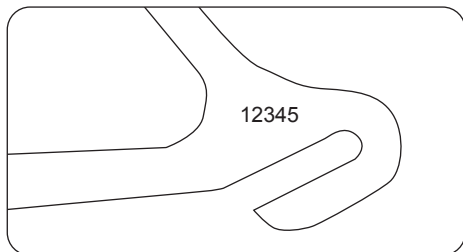

On no account should you ride with a bent or broken frame. Never attempt to repair damaged parts yourself. Otherwise, there is a danger of accidents. Faulty parts have to be replaced by a specialist retailer. Please only ride your bicycle again when the parts affected have been replaced.

Faults on the frame or other parts can cause accidents. If your bicycle does not ride in a straight line without any problems, this can be due to a bent frame or fork. Please contact a specialist retailer to have the frame and fork checked and possibly to have the bike realigned.

Maintenance / upkeep



Only have components replaced by original spare parts from the manufacturer or by parts approved by the manufacturer.



Please have your bicycle checked by a specialist retailer on a regular basis. These experts can identify damaged and worn parts and are able to advise you in selecting replacements. Refrain from repairing key parts yourself (frame, fork, handlebars, stem, headset, brakes).



Modern bicycle technology is high tech! Working on bicycle parts therefore requires special knowledge, experience and specialist tools! Please do not attempt to work on the bicycle yourself! Give your bicycle to a specialist retailer for repair, servicing and maintenance!



As is the case for all mechanical parts, bikes take on wear, tear and heavy use. Because of heavy use, different materials and components can react to wear and tear in different ways. If a component is used for longer than it is designed for, it may suddenly stop working and possibly lead to injury or cause additional damage. Any kind of rip, puncture or colour change seen in an overused area indicates that the component's use has reached its limit; the component should in this case be replaced. When replacing the original tires or the cranks, make sure that there is enough free space between the tires and the shoe. Accidents and severe falls could otherwise occur.



Screws and torque spanners

When working on the bicycle, please ensure that all screws are tightened to the correct torque. The required torque is printed on many parts with a screwed connection.

Measurements are given in Newton metres (Nm) and applied with a torque wrench. It is best to use a torque wrench that displays the tightening torque as it is in use. Otherwise screws can snap or break. If you don't own a torque wrench then you should always leave this work up to a specialist retailer!

A table listing the most important torques for bolted connections is provided on page 33.

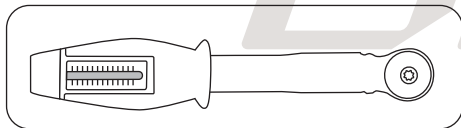

Torque spanner



Wear suitable protective clothing, protective gloves and protective goggles during all installation and maintenance work. Otherwise, contamination or injuries, that might be caused by lubricants and auxiliary materials among other things, could be the result.

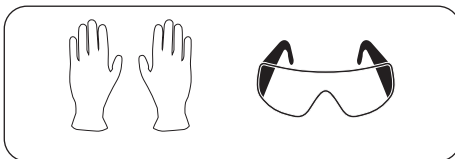

Chain

To ensure that it can work effectively, the chain has to be cleaned and greased regularly (see page 32). Dirt can be removed when washing the rest of the bicycle. Otherwise you can clean the chain by rubbing it with an oily cloth. When the chain is clean, it should be greased at the joints with suitable lubricant. After being left to soak, the excess lubricant should then be removed

Chain tension



To ensure that the chain and gears can work safely, the chain has to have a certain level of tension. Derailleur gear systems tense the chain automatically. In the case of hub gears which were installed without a chain tensioner, chains which are too loose have to be tightened. Otherwise they can come off and lead to a fall.



Please ensure that axle nuts, quick releases and through axles are correctly attached!



In the case of bicycles with adjustable dropouts, the mounting screws of the axle housing should be loosened and tightened, and not the axle nuts. If the bottom bracket shell contains an eccentric bush, please tighten the chain according to the instructions provided by the corresponding manufacturer.

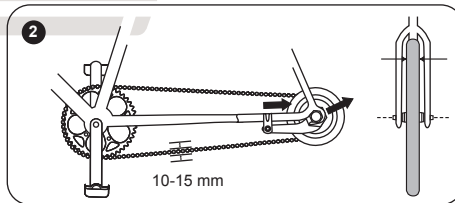
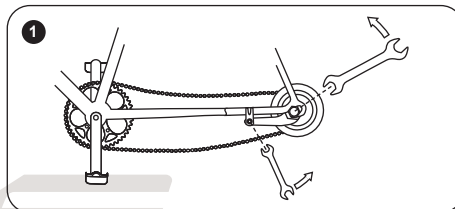

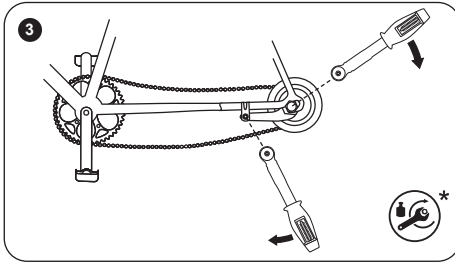

i Dirt and permanent strain wear the chain. The chain should be replaced as soon as it can be significantly lifted (approx. 5 mm) from the front chain ring. Many modern chains for derailleur gear systems no longer have chain connectors. You therefore require specialist tools to open/change/close them. This work should be carried out by a specialist retailer. Other chains are supplied/assembled with chain connectors. In some cases, these can be opened without the need for tools. These chain connectors can also be used to repair a damaged chain on a ride, if they have the correct width for the drive train.

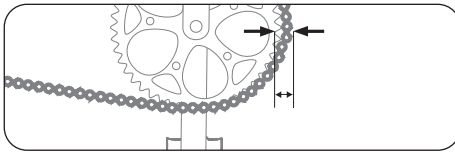

Measuring chain wear

Dirt and permanent strain wear the chain. With a caliper or chain checker you can evaluate the chain wear.

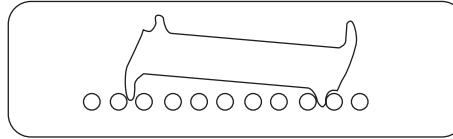

Measuring the chain wear. On a new chain the caliper does not sink in.

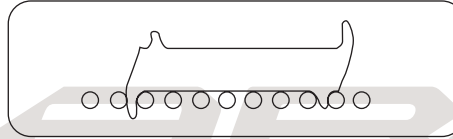

If a chain is worn out like this, the tool will sink in completely. This chain must be changed.

i If you miss to change a worn chain, cassette and chainring will show premature wear and abrasion. Early failure and higher costs might be the consequence.

Belt drive



If your bicycle is equipped with a belt drive, please read the attached component manufacturer's operating instructions before first use.

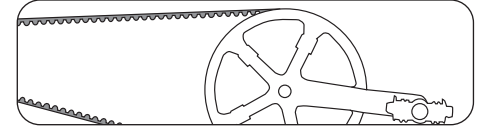

Wheels

Checking the wheels

The bicycle is connected to the ground by the wheels. The wheels are subject to a great deal of strain through the uneven characteristics of the ground and the weight of the rider.

Thorough checks and centring work on the wheels are undertaken before handing over the bike. However, during the first few kilometres of riding, the spokes bed in.

- After the first 100 kilometres (62 miles), the wheels have to be checked by a specialist and centred again if required.
- The tension of the spokes has to be checked at regular intervals. Loose or damaged spokes have to be replaced or centred by a specialist retailer.

The wheels can be fixed in the frame and fork in different ways. Commonly, the wheel is attached with an axle nut or a quick release. In addition, there are also various thru axle connections which are screwed in or fixed with various quick release systems.



If a quick release axle is fitted on your bicycle, you can get more information in the chapter "Using quick releases and thru axles" the enclosed manufacturer operating manual or on the manufacturer's website on the Internet.



All screw connections have to be tightened with the correct torque. If the torque is not correct, the screws could break or loosen other parts (see page 33 "Torques for screwed connections").

Checking the hubs

You can check the hub bearings as follows:

- Raise the wheel off the ground, lifting the bicycle first at the front and then the rear. Push each wheel to start them turning.
- The wheel should continue to turn and then slow evenly. If the wheel suddenly stops, the bearing is defective. One exception is front wheels with a hub dynamo. These display a rather greater degree of resistance. This is barely noticeable when cycling, but is noticeable in this test.

- The hub bearing should not exhibit play. Pull the wheel to the right and left in its forks or in the chain stays to establish whether it is loose. There should be no play noticeable.
- If the wheels can be slightly moved in their bearings or are difficult to turn, the hub bearings have to be set up by a specialist retailer.

Rims/tires



Normal operation wears down brake rubbers and brake pads. You should therefore regularly check the condition of your braking system and brake pads! Replace worn brake pads and rubbers in good time! Ensure that rims and brake discs are clean and free of any oil!

Clean the rims regularly according to the inspection plan on page 30. As part of this, you should also check the wear indicators:



Modern rims (from 24") indicate when they are worn from braking. These indicators take the form of embossed or coloured points or lines on the brake surfaces of the rims. When these disappear, you are no longer permitted to use the rims. There are also similar indicators which only appear after a certain level of wear. At the very latest when two pairs of brake rubbers have been worn, it is necessary to have the rims checked by a specialist retailer.

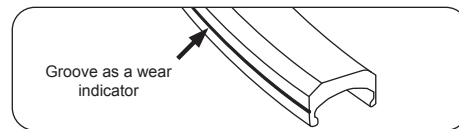

Rims are subject to a great deal of strain and are vital to your safety on the bike. Riding wears rims down over time, particularly on bicycles with rim brakes. If you notice any damage or the wear indicators show dangerous levels of wear, you should no longer ride with these rims. Have them checked by a specialist retailer and replaced if required. Wear can weaken rims and lead to falls and serious accidents.



In particular, rims made of composite materials, such as carbon fibre, require special attention. Friction caused by the rim brakes, but also by simply riding the bike, puts a substantial amount of strain on the bike.

- Only use brake pads that are designed for use on the rims' material.
- Each time before riding the bike, check for wear, tear, defects, cracks and chipping on the rims and wheels when they are made of composite materials!
- If you find any changes, do not ride the bike with this part until a specialist retailer or manufacturer has checked the part and deemed it to be fully functional.

- Never expose components made of carbon fibre to high temperatures. Intense sunlight can produce high temperatures, for example when the wheel has been stored in a vehicle. This could damage the component's structure. Failing parts, falls and very serious injuries could result.



The permitted tire pressure may not be exceeded when inflating the tires. Otherwise this could lead to the danger of a tire exploding. The tires have to be pumped up with at least the stated minimum tire pressure. If the tire pressure is too low, there is a possibility that the tire could free itself from the rim.

On the side surface of the tire, there is information on the maximum permitted tire pressure and generally also on the minimum permitted tire pressure.

If you replace the tires, only exchange them for the same model with the same dimensions and profile. The bicycle's handling could otherwise be negatively affected. This may lead to accidents.



Tires are available in various dimensions. The tire dimensions are stated with normed information.

Example 1: "46-622" states that the tires have a width of 46 mm and the rim has a diameter of 622 mm

Example 2: "28 x 1.60" states that the tire has a diameter of 28 inches and a width of 1.60 inches

Tires and tire pressure

The amounts for the recommended tire pressure can either be named in bar or PSI. The following table presents the conversions for the usual pressure levels and shows which tire widths these pressures should be applied to.

<i>Rider weight in kg</i>	<i>Tire width 23mm</i>	<i>Tire width 25mm</i>
< 50	6.0 bar 87 psi	5.5 bar 80 psi
60	6.5 bar 94 psi	6.0 bar 87 psi
70	7.0 bar 101,5 psi	6.5 bar 94 psi
80	7.5 bar 109 psi	7.0 bar 101.5 psi
90	8.0 bar 116 psi	7.5 bar 109 psi
>=100	8.5 bar 123 psi	8.0 bar 116 psi



Please also inform yourself using the information provided by your tire manufacturer. This could possibly be different from the tire pressures listed here. Not adhering to these guidelines can lead to damage to your tires and inner tubes.



You should also regularly check your bicycle's tires. The minimum and maximum permitted tire pressure is printed on the side of the tires. Please adhere to these levels, otherwise the tires could slip off the rims or explode! If the inflation pressure rating indicated on the tire and on the rim differ, the lower maximum pressure and the higher minimum pressure apply.

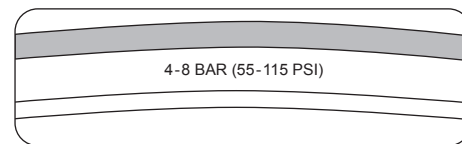

Example of tire pressure information



Tires are wearable parts. You should therefore regularly check the pressure, tread and condition of your tires. Not every tire is designed for every type of use. Allow a specialist retailer to advise you when selecting tires.



When replacing the original tires or the cranks, make sure that there is enough free space between the tires and the shoe. Accidents and severe falls could otherwise occur.



Your bicycle can only function safely and effectively if you replace parts with suitable, authorised replacements. Please consult your manufacturer, importer or specialist retailer for advice on suitable replacement parts.



Only replace broken or worn key parts with original replacement parts from the manufacturer or parts approved by your manufacturer. This is mandatory in the case of light systems, while the manufacturer's warranty and/or guarantee is usually nullified if you install non-approved replacement parts.



If you install non-original or false replacement parts, this can lead to severe loss of function! Tires with poor grip or safety, brake pads with a low friction coefficient and incorrectly installed or poorly made lightweight components can all lead to potentially serious accidents. The same applies for improper assembly!

Tubeless tires

If your bicycle is fitted with tubeless tires, please read the instructions provided by your manufacturer covering the tires and rims.



Only use tubeless tires on rims intended for this purpose! This will be marked on the rims, with the abbreviation "UST" for instance.



Only use tubeless tires in the prescribed way, with the correct air pressure and the recommended sealant if required.

Tubeless tires can only be mounted and removed from the rims without tools, otherwise this could lead to leaks. If the sealant is not sufficient for preventing damage, a normal tube can be used after removing the valve from the tubeless system.



Tubular tires

Mountain bikes are also fitted with tubular tires. For more information on these, please refer to the enclosed instructions from the manufacturer.



Only use tubular tires on rims intended for this purpose! These do not have rim flanges but smoothly curving surface, from the outside inwards. This is where the tubular tires are fitted.



Only use tubular tires in the prescribed way and with the correct air pressure.



Attaching tubular tires requires expert skills and lots of experience! Always have your tubular tires changed by a specialist. Inform yourself about how to handle and change this type of tire!

Flat tire repair for conventional tires

You will require the following equipment:

- Tire lever (plastic)
- Patch
- Rubber solution
- Sandpaper
- An open-ended wrench for wheels without a quick release
- Pump
- Replacement inner tube

1. Open the brake

Opening **cantilever** or **V-brakes**:

- Grip one hand around the wheel
- Push the brake arms against the rim
- Remove the brake line or line casing on one side

Removing **hydraulic rim brakes**:

- If your system features a brake quick release, remove the brake unit according to the instructions supplied by your manufacturer.
- If you do not have a brake quick release, deflate all of the air out of the tire

Opening **side-pull caliper brakes**:

- Open the quick release lever on the brake arm or lever, or:
- If you do not have a brake quick release, deflate all of the air out of the tire. Now the wheel can be pulled out from between the brake pads.

Gear hubs, roller, drum or back pedal brakes are opened as follows:

- Loosen the cable anchor or quick release on the brake arm.
- In the case of back pedal brakes, the screws on the brake arm of the chain stay have to be opened..

Disk brakes:

- The wheel can be removed without any further preparation.
- Please note: when fitting the wheel, the disk must be slotted between the brake linings of the brake calliper and ultimately be centred without contact

2. Removing the wheel

- If your bicycle has quick-release levers or axles, open them (see page 7).
- If your bicycle has hex nuts, loosen these with a suitable spanner anti-clockwise.

You can then remove the front wheel according to the steps listed above.



Source: Shimano® techdocs

Make sure you don't touch the disc while taking the wheel out and in again.

The following applies for rear wheels:

- If your bicycle uses a derailleur gear system, change gear to the smallest sprocket. In this position, the rear derailleur poses the least hindrance in removing the wheel.
- If your bicycle has quick-release levers or axles, open them (see page 7).
- If your bicycle has hex nuts, loosen these with a suitable spanner anti-clockwise.
- Pull the rear derailleur backwards somewhat.
- Lift the bicycle slightly.
- Lightly strike the wheel from above with the palm of the hand.
- Take the wheel out of the frame.

If your bicycle has a gear hub, please consult the instructions supplied by your manufacturer for removing the wheel.

Types of valve on bicycle tubes

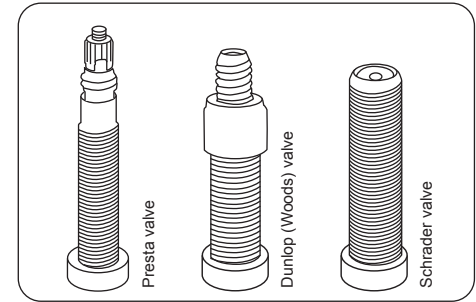

3. Removing the tire and inner tube



For tube tires, see page 22.

- Unscrew the valve cap, the fastening nut and possibly the cap nut from the valve. In the case of Dunlop or Woods valves, remove the valve stem.
- Release all of the remaining air from the inner tube.
- Insert the tire lever opposite the valve on the inside of the tire.
- Insert the second tire lever approx. 10 cm from the first, between the rim and tire.
- Lift the tire wall over the edge of the rim.

- Repeat this lifting action around the wheel until the entire tire is free.
- Remove the inner tube from the tire.

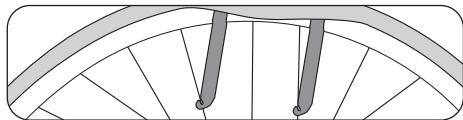

4. Change the inner tube

Switch the inner tube for an intact one.



For the change of tubular tires and tubeless tires follow the instructions of the rim or tire manufacturer.

5. Reassembling the tire and inner tube



Please avoid allowing foreign bodies inside the tire. Ensure that the inner tube does not have any folds and is not squashed. Ensure that the rim tape covers all spoke nipples and does not have any damage.

- Place one edge of the rim into the tire.
- Push one side of the tire completely into the rim.
- Insert the valve through the valve hole in the rim and put the inner tube into the tire.
- Pull the second side of the tire into the rim with the balls of your hands.

- Ensure that the inner tube is correctly positioned.
- In the case of Dunlop or Woods valves: Push the valve stem into the right position and tighten the cap nut.
- Pump the inner tube up somewhat.
- Check that the tire is properly in place and runs true using the control ring on the side of the tire. Adjust the positioning of the tire with your hand if it does not quite run true.
- Pump the inner tube up to the recommended tire pressure.



Please take note of the running direction of the tire when installing it.

6. Reattaching the wheel

Reattach the wheel securely back in the frame or fork with the corresponding quick release, bolted connection or full floating axle mechanism.



If your bicycle has disc brakes, please ensure that the brake discs are correctly secured between the brake pads!



Read the gear manufacturer's instructions to correctly and safely assemble and set up derailleur gear systems.



Tighten all screws to the recommended torque. Otherwise the screws could break and parts could fall off (see page 33).

- Connect the brake line, attach it or close the brake quick release.
- Check if the brake pads are aligned with the brake surfaces.
- Test the brakes.

Brakes

Modern bicycles can be equipped with a variety of different braking systems.

There are various options:

- Rim brakes in the form of V-brakes, cantilever or side-pull caliper brakes

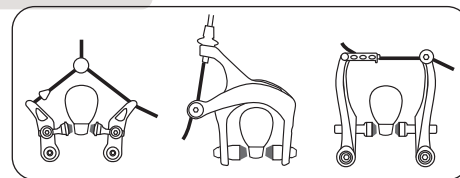

- Hydraulic rim brakes

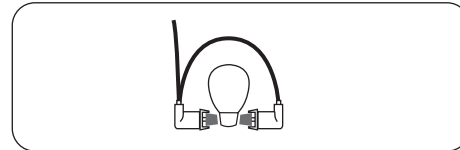

- Disc brakes with hydraulic or mechanical operation

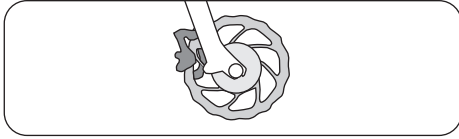

Various versions of disk brakes are available for racing and cyclo-cross bikes. Always read the enclosed instructions from the component manufacturer before the first ride. Make sure you practice and get used to operating the brakes on safe terrain before going on your first bike ride!



Almost all modern brakes provide considerably more braking power than was available for bicycles in the past. Carefully familiarise yourself with them, practising using the brakes and even emergency braking, starting on safe ground with no traffic before setting out into the traffic.



When cycling down a long or very steep slope, do not keep the brakes applied all the time or slow yourself down with one brake only. This can result in overheating and therefore the loss of braking power through fading. Braking properly and safely involves using both brakes evenly. The only exception is if you are cycling in slippery conditions such as on sand or a smooth surface. You should then exercise great care, slowing yourself down mainly with the rear brake. Otherwise there is the risk of the front wheel slipping out to the side and causing a fall. On extremely long downhill sections, you should not be gently braking the whole time. It is better to brake more sharply for a shorter period going into a bend or if you are starting to go too fast. This allows the brakes time to cool down again between applications. This preserves your braking power.



Your bicycle is supplied with the corresponding operating manual for your specific braking model. You can get more information about the brakes on your bicycle in the operating manual provided by your manufacturer or on the manufacturer's website.



Brakes are vital to your safety on the bike. You should therefore maintain them on a regular basis. This requires specialist knowledge and tools. Allow your specialist retailer to do this type of work on your bicycle! Work that is improperly carried out endangers your safety on the bicycle!



No oil-based liquids should ever be applied to brake pads, rim brake surfaces, brake shoes or brake discs. These substances impair the performance of the brakes.

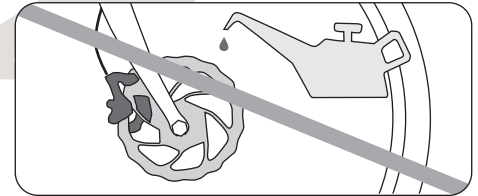

Brake pad wear



Normal operation wears down brake rubbers and brake pads. You should therefore regularly check the condition of your braking system and brake pads! Replace worn brake pads and rubbers in good time!

Ensure that rims and brake discs are clean and free of any oil!

The brake pads for rim brakes are almost all fitted with grooves or notches. The grooves and notches serve in part to help identify the wear level of the brake pads. Replacing rubber brake blocks. If the grooves are no longer visible, this is a sign that you should replace the brake pads.

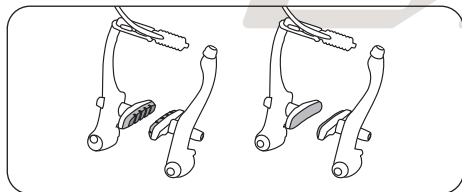

If a brake pad is grazing against the rim: The spring setting allows you to set the return force in such a way that both brake pads lift evenly from the rim when you release the brake lever. Then check that the brakes are working properly.

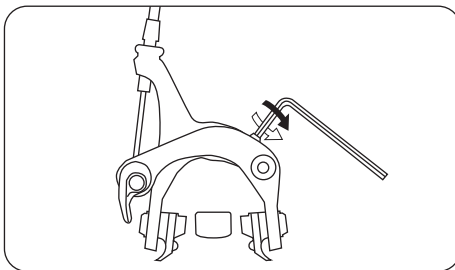

Setting up the distance between the brakes and the rim

Source: Shimano® techdocs



After undertaking any work on your braking system, carry out at least one trial braking manoeuvre on safe ground without any traffic, before setting out into the traffic.



Have the brake fluid replaced on a regular basis. Check the brake shoes regularly and have them replaced when they are worn out. You will find further information in the brake manufacturer's instructions for use.

Disk brakes



In particular, brake disks and brake pads are subject to wear. Please allow a specialist retailer to check these key parts on a regular basis and replace any worn parts if necessary.

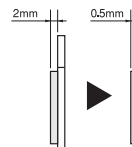

Source: Shimano® techdocs

Hydraulic disk brakes

Hydraulic disk brakes can be operated with conventional brake/shift levers using various adapters. When working on the stem and headset, particular attention should be paid that the adapters are securely attached and are working correctly.

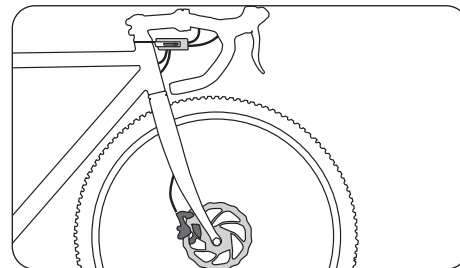



If your bicycle comes equipped with a converter, which makes it possible to operate hydraulic brakes with mechanical brake levers, read the attached component manufacturer's operating instructions before using it.

Bedding in disc brakes

New disc brake pads and brake discs have to be carefully bedded in before the first ride. This process optimises brake performance.



The bedding-in process involves sharp braking. You must be familiar with brake performance and the operation of disc brakes. Sharp braking, without being familiar with brake performance and the operation of disc brakes, can lead to accidents causing severe or fatal injury. If you are unsure, you should have a qualified bicycle mechanic perform the bedding-in process for you.

Proceed as follows:

To bed in the brakes, accelerate the bicycle to 30 km/h and then bring the bicycle to a halt by applying maximum braking. Repeat this process around 20 times.

For optimal results, the wheels should not be allowed to lock.



Please do not touch the brake disk while it is rotating or directly after braking. This could result in injury or burns.



Source: Shimano® techdocs

Vapour bubbles in the disc brakes



Avoid permanently braking for longer periods, as can be the case during long, steep descents. Otherwise this can allow vapour bubbles to form and cause a complete failure in the braking system. This could result in serious falls and injury. The brake lever may not be applied if the bicycle is on its side or upside down. Otherwise air bubbles can enter the hydraulic system which could cause the brakes to fail. After transporting the bicycle, check if the pressure point of the brakes seems softer than it was before. Then apply the brakes slowly several times. This allows the braking system to discharge any bubbles. If the pressure point remains soft, please refrain from riding. A specialist retailer has to then discharge the air from the brake system.



You can avoid this problem by applying the brake lever before transport and then fixing it in this position using a strap. This prevents any air from entering the hydraulic system.

When you come to cleaning the braking system, please first read the instructions provided by the component manufacturer.

Gears

This operating manual describes the use of common commercial gear components on a bicycle as an example. If your components are different, you will find specific information in the respective operating manual or on the manufacturer's website. If you have any questions about assembling, maintaining, setting up or operating the gears, please contact your bicycle specialist retailer. Use the shifter to change gears. Changing the gears will increase or decrease the force or speed of the bike as needed. In lower, easier gears, you can easily ride uphill and lower physical strain. In higher gears, which are harder to peddle in, you can reach higher speeds and pedal at a lower cadence. You should generally aim at riding the bike at a higher cadence and in lower gears. Modern bicycles can be equipped with a variety of different gear systems.

The gear lever can be operated as shown in this example:

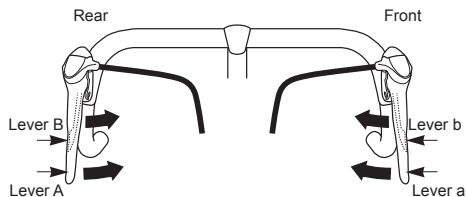

- Lever (A): Changing to a larger rear sprocket.
- Lever (B): Changing to a smaller rear sprocket.
- Lever (a): Changing to a larger chain ring.
- Lever (b): Changing to a smaller chain ring.

All levers return to their original position after being released.

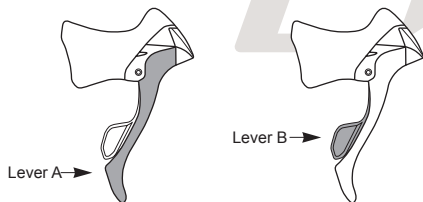

Source: Shimano® techdocs

SRAM® racing bike gear shifters are operated differently. A RED shifter serves as an example here:

The shifter behind the right hand brake lever switches the chain on the rear sprockets. Operating the shifter over its short travel switches to a smaller sprocket and with the longer travel to a larger one.

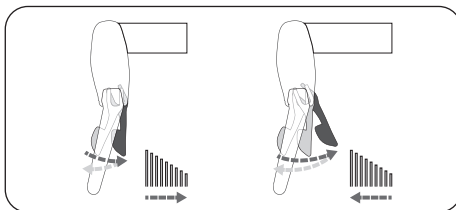

The shifter behind the left hand brake lever switches the chain onto the small chain wheel at the front over its short travel and onto the large chain wheel with the longer travel.

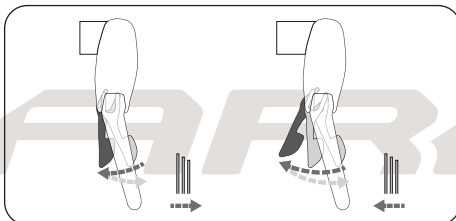

Source: SRAM®



Your bicycle is supplied with the corresponding operating manual for your specific gear system. You can get more information about the gears on your bicycle in the operating manual provided by your manufacturer or on the manufacturer's website.



Gears are vital to your safety on the bike. Please read the operating instructions supplied to you by your manufacturer and familiarise yourself with how to operate the bicycle and switch gears before your first ride. Allow your specialist retailer to undertake any work on your bicycle's gears! Work that is improperly carried out endangers your safety on the bicycle!



Do not pedal backwards while changing gears as this could damage the gear system. Changes to the setup of your gears should only be made in small steps and with the greatest of care. Incorrect setup work can lead to the chain coming off the sprockets and causing a fall. If you are at all unsure, contact a specialist retailer who can set this up for you.



Despite a perfectly set up chain gear system, a bike chain crossing at an angle can lead to noises during riding. These noises are normal and do not cause any damage to the gear components. These noises are normal and do not cause any damage to the gear components.

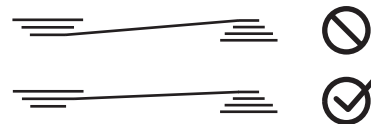



The use of spoke guards is required. Otherwise, only minor setup errors could lead to the chain or the entire rear derailleur falling between the sprockets and the spokes.

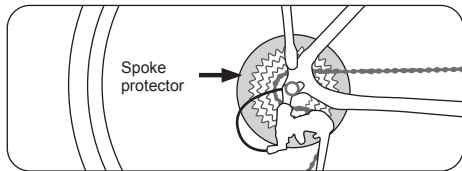

Triathlon/TT bike

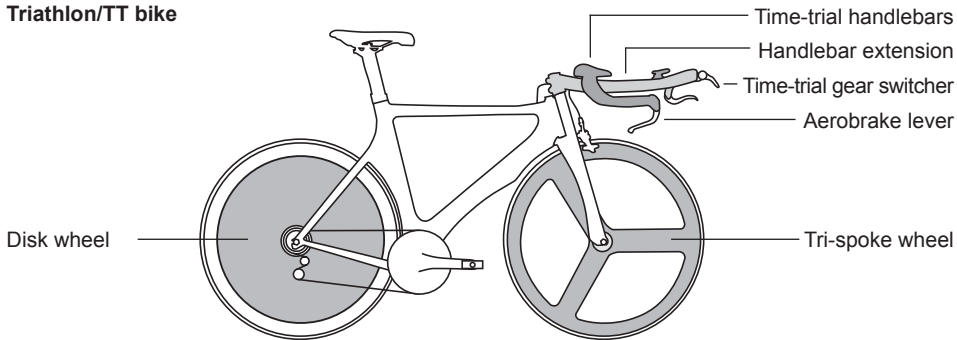

Electrical/electronic gear shifting system

If your bicycle is equipped with a gear system which sends its shifting signals electronically: For operation and upkeep read the enclosed instructions from the respective manufacturer. Allow a specialist retailer to work on the electronic circuit. Ask a specialist retailer to inform you about the use and maintenance of this part.

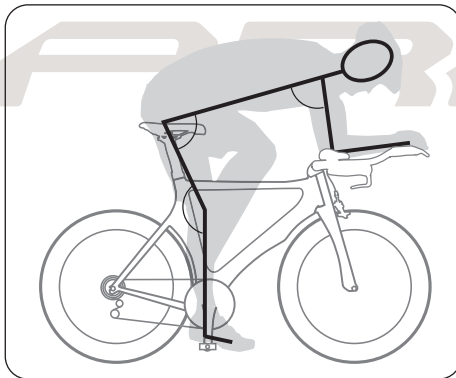
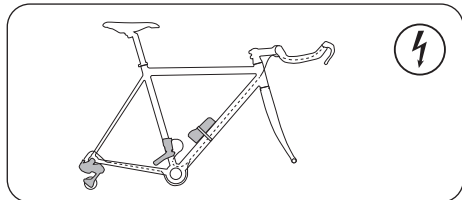

Position for TT and triathlon



The seat and handlebar position of time trial and triathlon bikes is considerably different from that of conventional racing bikes. Please allow specialists to advise you on the seating position of your time trial or triathlon bike.

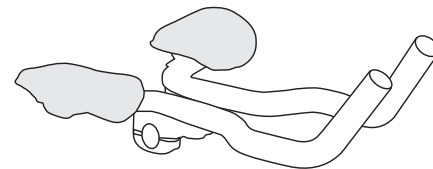

Time trial/triathlon handlebar attachment



The behaviour of a bicycle with a TT handlebar or attachments can be dangerously different to what you are used to. The movement required of the hands from the time trial position to the brake or gear handles is also longer and unfamiliar. Please practice this in a safe area until you have mastered the controls of the bicycle.

Disc wheels, special wheels

If your bicycle has disk wheels, tri-spokes or other types of wheels, please ensure that you familiarise yourself with how to handle and care for them.



Special wheels can behave differently than you are used to when riding, braking and steering. Trispokes and disk wheels in particular are more sensitive to wind than conventional wheels. Rims made of something other than aluminium can provide different, and perhaps considerably less effective, braking than you are used to. Familiarise yourself with your new bicycle and its behaviour in a safe, quiet area.

Inspection plan



Only use parts of the same brand and construction type when changing or replacing components on your bicycle. Otherwise your guarantee and the manufacturer's liability for faults are invalidated (warranty).



Modern bicycle technology is highly efficient but also sensitive. You should service your bicycle on a regular basis. This requires specialist knowledge and tools. Allow your specialist retailer to do this type of work on your bicycle! You can get more information about your bicycle's parts as well as cleaning and maintenance in the operating manual provided by your manufacturer or on the manufacturer's website.

Work which you are able to carry out yourself with no risk to safety is printed in **bold**.

To ensure that your bicycle remains in a safe condition and fulfils the conditions of the warranty, the following terms apply:

- **Clean your bicycle after every ride and check it for possible damage.**
- **Allow a specialist retailer to carry out inspections.**
- **Check your bicycle every 300 – 500km or every three to six months.**
- **Check that all screws, nuts and quick releases are secure.**
- **Use a torque spanner to tighten screw joints!**
- **Clean and grease moving parts (excluding brake surfaces) according to instructions from the manufacturer.**
- **Allow a specialist retailer to touch up any paint damage.**
- **Ask a specialist retailer to replace any broken and worn parts.**

Schedule and inspection work

Before every ride:

Work undertaken

Maintenance/inspection:

Check the following:

- **Spokes**
- **Rims for wear and concentricity,**
- **Tires for damage and foreign bodies**
- **Quick releases**
- **The functionality of the gears**
- **The functionality of the brakes**
- **Hydraulic brakes for possible leaks**
- Tubular tires and tubeless tires: for secure assembly and correct tire pressure**

After riding 200 kilometres from purchase, then at least once a year:

Work undertaken

Check the following:

- **Tires and wheels**

Torques:

- Handlebars • Pedals
- Cranks • Seat
- Seat post • All mounting screws

Make possible adjustments to the following components:

- Headset • Gear system
- Brakes

Every 300 to 500 kilometres:

Work undertaken

Check the following:

- **Chain** • **Gearside** • Rims
- **Sprockets** • **Belt drive**
- Check the brake pads for wear, replace them if required

Clean:

- **Chain** • **Gearside**
- **Sprockets** • **Belt drive**

Grease:

- **The chain with suitable lubricant**

Check the following:

- All screw joints are secure

Every 3000 kilometres:

Work undertaken

Have the following checked, cleaned or replaced by your specialist retailer:

- Hubs • Headset • Brakes
- Pedals • Gear system

After rides in the wet:

Work undertaken

Cleaning and greasing:

- **Gears** • **Brakes (excluding brake surfaces)**
- **Chain**



Ask your specialist retailer for suitable lubricants! Not all lubricants are designed for all purposes. Using the wrong lubricants can lead to damage and impact the part's performance!



The first inspection is particularly important for ensuring that your bicycle remains safe and problem-free! Cables and spokes stretch, while bolted connections can loosen. Therefore always allow a specialist retailer to carry out the first inspection.

Lubrication



Working on the bicycle requires special knowledge, experience and special tools! Only allow specialists to work or check key parts on the bicycle!

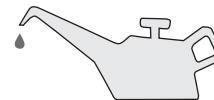

Lubricant schedule

What should be greased?	How often?	With which lubricant?
Chain	After cleaning off any dirt, after riding in the wet, every 250 km	Chain lubricant
Brake and shifter cables	When their performance deteriorates, once a year	Silicon-free lubricant
Wheel bearings, pedal bearings, bottom bracket	Once a year	Bearing grease
Threads during assembly	During assembly	Assembly grease
Contact surfaces of carbon parts	During assembly	Carbon assembly paste
Sliding surfaces of quick releases	Once a year	Grease, spray lubricant
Metal seat post in metal frame	During assembly	Grease
Links in the gear system	When their performance deteriorates, once a year	Spray lubricant
Brake links	When their performance deteriorates, once a year	Spray lubricant

Bolted connections



It is vital that all bolted connections on the bicycle have the correct torque in order to ensure that they are secure. Too much torque can damage the screw, nut or component. Always use a torque spanner to tighten screw joints. You are not able to correctly tighten these bolted connections without this specialist tool!



If a component specifies a torque for its bolted connections, then this should be strictly adhered to. Please read the instructions provided by the manufacturer, which lists the correct mounting torques.

<i>Bolted connection</i>	<i>Torque</i>
Crankset arm, steel	30 Nm
Crankset arm, aluminium	40 Nm
Pedals	40 Nm
Front wheel nut	25 Nm
Rear wheel nut	40 Nm
Stem expander bolts	8 Nm
Threadless stem clamping bolts	9 Nm
Seat post clamping bolt M8	20 Nm

<i>Bolted connection</i>	<i>Torque</i>
Seat post clamping bolt M6	14 Nm
Screw of seat rails to seat post clamp	20 Nm
Brake blocks	6 Nm
Dynamo attachment	10 Nm

Differences for carbon components:

<i>Bolted connection</i>	<i>Torque</i>
Front derailleur bracket attachment screw	3 Nm*
Shift lever attachment screw	3 Nm*
Brake lever attachment screw	3 Nm*
Handlebars - stem clamping	5 Nm*
Stem - fork tube clamping	4 Nm*

<i>Bolted connection</i>	<i>Thread</i>	<i>Torque Max.</i>
Seat post clamp, loose	M 5	4 Nm*
Seat post clamp, loose	M 6	5,5 Nm*
Derailleur hanger	M 10 x 1	8 Nm*
Bottle holder	M 5	4 Nm*

<i>Bolted connection</i>	<i>Thread</i>	<i>Torque Max.</i>
Bottom bracket	BSA	according to manufacturer's instructions*
Brake caliper, disk brake, Shimano (IS and PM)	M 6	6 – 8 Nm
Brake caliper, disk brake, AVID (IS and PM)	M 6	8 – 10 Nm
Brake caliper, disk brake, Magura (IS and PM)	M 6	6 Nm

General torque for bolted connections

In general, the following torques can be used for bolted connections:

<i>Dimensions</i>	<i>Screw quality</i>			<i>Unit</i>
	8.8	10.9	12.9	
M4	2.7	3.8	4.6	Nm
M5	5.5	8.0	9.5	Nm
M6	9.5	13.0	16.0	Nm
M8	23.0	32.0	39.0	Nm
M10	46.0	64.0	77.0	Nm

* Use of carbon assembly paste is recommended

Loose accessories



You always have to fit the enclosed accessories in line with the guidelines and instructions. You have to ensure that screw connections are secured with the correct torque (see page 33 "Torques for screwed connections").

- Only use add-on parts that comply with the respective legal regulations and the road traffic regulations.
- The use of unauthorised accessories may lead to accidents or severe falls. You should therefore only use original accessories and add-on parts which fit your bicycle.
- Allow a specialist retailer to advise you



Loose luggage rack



Only install baggage racks on bicycles which are suitable for this kind of equipment. Use only the intended fixing devices. If you own a frame or parts made of carbon, ask your specialist retailer for transportation of luggage. Don't fix racks at the seat post! It is not constructed for this use. An overload of the seat post by a rack can result in a break of the seat post and serious accidents.

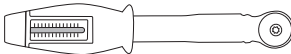

Transporting baggage changes the behaviour of your bicycle. In particular, it increases the braking distance, which can lead to serious injuries. Please adjust your riding style to this, i.e. brake earlier and anticipate more sluggish steering. Only transport baggage on racks intended for this purpose! Never attach a

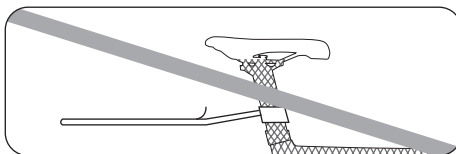

When loading luggage racks, please make sure not to cover front or rear lights or reflectors!

Avoid uneven loading of the luggage racks.



Not all carbon frames and components are compatible with each other! Read the specific manufacturer's instructions. Seek advice from your specialist dealer.

baggage rack to the seat post! It is not designed for this purpose. Subjecting this part of the bicycle to excess weight with a rack can lead to breaks in the seat post and serious falls!

- Only mount child seats on baggage racks if they have the corresponding holders and the manufacturers permit this.
- Please ensure that nothing can get caught in the spokes and turning wheels.



If you are riding with baggage, ensure that you do not exceed the maximum permissible weight of the bicycle (see page D). Information on the weight capacity of the rack is also stated here.



When loading luggage racks, please make sure not to cover front or rear lights or reflectors!

Avoid uneven loading of the luggage racks.

Front rack



Front racks are attached to the front axle or the front fork. Front racks have a strong impact on the bicycle's behaviour! Please practice riding in a safe area before riding with a loaded front rack for the first time!

Mudguards

Mudguards are fixed correctly in place with special braces. If the inside of the mudguard runs parallel to the tire forming a ring shape, the braces are perfectly positioned. During normal use, the mudguard should not loosen. In the case that an object becomes jammed between the mudguard and the tire, the mudguard is fitted with a safety fastening. This releases the mudguard from its holder to prevent a fall.



You have to stop riding immediately if a foreign body is trapped between the tire and the mudguard. The foreign body has to be removed before you can continue on your ride. Otherwise, there could be a risk of a fall and serious injuries.



On no account should you continue riding with a loose mudguard brace, as this could become wedged in the wheel and jam it.

Damaged mudguards have to be replaced by a specialist retailer before riding again. In addition, you should regularly check whether the braces are fixed securely in the safety releases.

Re-locking a safety release

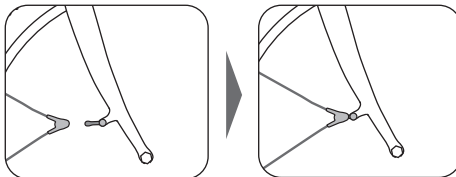

The diagram features a brace attached with a plastic clip,

- this clip is locked into the clip stay on the fork
- the mudguards have to be aligned in such a way that they do not contact the tires.

Trailers

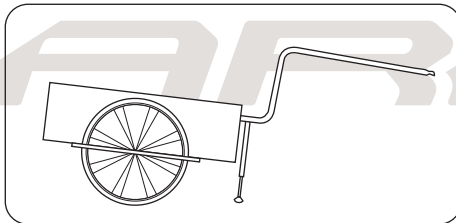

Check whether it is permissible for your bicycle to be used with a trailer. Your specialist dealer should have entered this on the "Handover documentation" page.

Use a tested trailer only. This can be seen from the presence of a "GS" safety-tested mark, for example. Seek advice from your specialist dealer. He will also ensure that the necessary coupling is securely fitted.

Bear in mind that when towing a trailer your bicycle is much longer than it normally is. A bicycle towing a trailer also behaves differently through bends than one without a trailer. Accordingly, you must be very careful in traffic. First practice with an empty trailer on safe ground with no traffic, before setting out into the traffic.



Read the manufacturer's instructions for use as they often contain important information for cycling with a trailer. Visit the corresponding website. Check whether the trailer manufacturer has stipulated a maximum load and permitted maximum speed. You must observe these values. In some countries, children under the age of 16 are not allowed to cycle towing a trailer.

How to use carbon components



If you have a carbon frame or parts, these should not be applied with grease or oil. Please use special assembly paste for carbon parts.

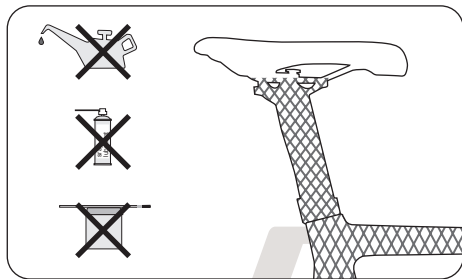

Carbon is a material which requires special handling and care during construction, servicing, riding, transport and storage.

Properties of carbon

Carbon frames are often used for racing bicycles. The term carbon is commonly used for a composite material of carbon fibres embedded within a plastic matrix in a number of layers. The material is extremely light but still extremely strong. However it is susceptible to impacts and dents.



Carbon parts cannot be bent, dented or misshapen after an accident/fall. If this is the case, it is possible

that the fibres have been destroyed or have broken off, e.g. within the part, which is not visible from the exterior!

Therefore, it is vital to regularly check carbon frames and other carbon components very carefully, especially after a fall or an accident.

- Look for splinters, tears, deep scratches, holes or other changes in the carbon surface.
 - Check if the parts have got softer or less stiff than usual.
 - Check if individual layers (paint, finish or fibres) come off.
 - Listen for any cracking or other usual sounds.
- If you are not completely certain that your bicycle is in perfect condition, please allow a specialist retailer to check the affected carbon parts!



Some carbon components require lower torques than metal parts. Excessive torques can lead to hidden damage, which is possibly not visible from the outside. Frames or components can break or warp to such an extent that you could fall. Therefore please always adhere to the instructions supplied by the manufacturer or ask for advice from a specialist. Use a torque spanner to ensure that you get the required torque. Carbon parts may not be applied with grease or oil. Special assembly paste is available for assembling and safely securing carbon components with a low mounting torque. Never expose carbon parts to high temperatures! Even in the back of cars, the sun's

rays can generate such a heat that it can put the safety of carbon parts at risk.

Do not clamp a carbon frame directly into a work stand, instead you should secure it by the seat post. If the seat post is also made of carbon, use another tube made of metal.

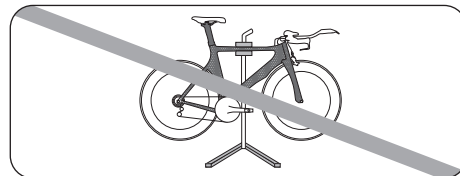

The following components and sections of carbon parts should be checked regularly (at least every 100 km or 62 miles) for irregularities such as cracks, breaks or surface changes, as well as after any accident or fall involving the bicycle: Transition area of the threaded bushing of the drink holder, slot of the dropouts, bearing areas in full-suspension frame, seat clamp, derailleur hanger, derailleur clamp area, disc brake mounting or brake boss, press-fit area of the headset as well as the threads of the bottom bracket cups.

Carbon =



Transporting the bicycle



By car

You should use only roof and rear-mounted carriers which comply with the requirements of the national licensing authority applicable to you. Roof, rear-mounted and other carriers which are officially approved are safe to use in traffic. Ensure the presence of a quality stamp such as a “GS” safety-tested mark.



Inappropriate bicycle carriers may cause accidents. Adjust your driving behavior to the load on your car roof.



The total height of your vehicle changes when you transport a bicycle on the roof!

Carefully attach the bicycle, so that it cannot come detached from the carrier. This could result in severe traffic accidents. Check the attachment several times during transport. Loose parts (tools, air pump or children’s seats) may detach during the drive and put other traffic participants at risk. Remove all loose parts before driving off. The bicycle may only be attached at the handlebars, stem, bicycle seat or seat post when this is intended by the carrier manufacturer. Do not use fasteners that could damage the bicycle fork or the frame.



Never fasten the bicycle to components made of carbon fibre.

Always transport bicycles on their wheels when not otherwise prescribed by the carrier manufacturer. You may not attach the bicycle to the roof rack or rear carrier by its crank set. It may come loose and cause a severe accident.

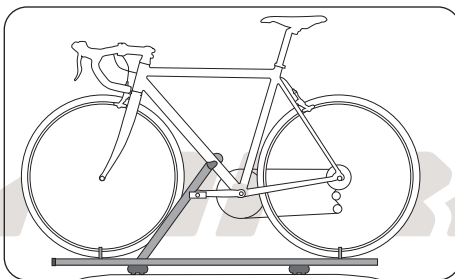

The manufacturers of add-on components and accessories also provide information regarding use and installation on their websites. Collect information when you use new components.



By Train

Local public transport systems have different regulations regarding transporting bicycles. Gather information concerning the opportunities for using buses and trains before starting the trip.

Train companies permit passengers to take bicycles with them in some, but not all, trains. If this is permitted, there are normally special places for bicycles. In some trains it is necessary to notify the company that you are taking a bicycle and wish to reserve a place.



By aircraft

Check with the airline regarding the regulations for the transport of sports equipment / bicycles. You might have to register the bicycle. Carefully package the bicycle to prevent transport damage. You can use a special bicycle container or a sturdy cardboard box for transport packaging. Please talk to your specialist retailer before carrying this out.

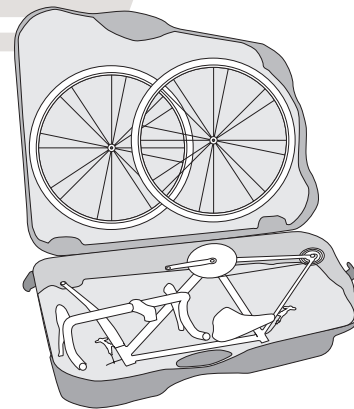

Warranty and liability in the case of defects



In all nations which apply EU law, the common conditions for warranty/liability for material defects apply. Please inform yourself about the applicable national regulations in your specific country.

Under EU law, the seller accepts liability for material defects for at least two years after the date of sale. This also covers defects which already existed at the time of sale/change of ownership. In fact, if material defects occur within the first twelve months, the assumption is made that these already existed at the time of sale.

Bicycles are complex vehicles. Therefore it is required to implement all service intervals properly. Omitting servicing puts the claim of the seller at risk if the error could have been avoided by servicing. The necessary maintenance is outlined in the chapters of these operating instructions and in the enclosed instructions from the component manufacturers.

In most cases, the customer can first request subsequent fulfilment.

If repair fails conclusively, which is the assumption after two attempts, the customer is entitled to abatement or cancellation of the contract.

Liability for material defects does not cover normal wear occurring from the product's intended purpose. Components in the motor and deceleration system as well as tires, light system and contact points of the rider with the bicycle are all subject to use-related wear.

If the manufacturer of your bicycle provides additional guarantees, seek advice from your specialist retailer. Please consult the respective warranty terms for more information on the conditions of these and of any possible claims under these.



In the case of a defect/possible liability claim, please contact your specialist retailer. We recommend filing all purchase receipts and inspection reports as proof for your records.

Environmental protection tips

General care and cleaning products

Please take the environment into account when caring for and cleaning your bicycle. You should use care and cleaning products which are biodegradable wherever possible. Please ensure that no cleaning fluid enters the drainage system. When cleaning the chain, use a suitable chain cleaning tool and dispose of chain lubricant properly at a suitable waste disposal site.

Brake cleaner and lubricants

Take the same approach to using brake cleaner and lubricants as you do to general care and cleaning products.

Tires and inner tubes

Tires and inner tubes are not residual waste or domestic rubbish and have to be disposed of at your local recycling centre.

Carbon parts and frames

Carbon parts and frames consist of carbon fibre matting stuck together in layers. We recommend allowing your specialist retailer to dispose of any discarded carbon parts.

Battery packs and batteries

Battery packs and batteries are not residual or domestic waste and must be handed over to your specialist dealer for disposal.



The transport packaging of this product must not be disposed of with household waste. You can return the packaging to the sender free of charge. The aim of offering this alternative option to return the used packaging is to ensure that it is collected separately from household waste so that it can be properly recycled or reused. Please note that you may need the transport packaging if you wish to return the pedelec. Please contact the manufacturer service hotline for more information.

Inspections

During the next inspection special care should be taken for:

Parts that should be changed:

Problems that occurred:

1st inspection
After approx. 200 kilometres
Work done:

Materials used:

Date, signature Retailer stamp

2nd inspection
After approx. 1000 kilometres
Work done:

Materials used:

Date, signature Retailer stamp



3rd inspection
After approx. 2000 kilometres

Work done:

Materials used:

Date, signature

Retailer stamp

4th inspection

Work done:

Materials used:

Date, signature

Retailer stamp

5th inspection

Work done:

Materials used:

Date, signature

Retailer stamp

Handover documentation

The bicycle listed in the section "Bicycle identification" was assembled properly and was delivered to the customer ready-to-use. **This complies with type _____, in the chapter "Intended Use".**

Functional checks for the following components:

- Wheels: spoke tension, sturdiness, concentricity, correct tyre pressure
- All screw joints: secure, correct mounting torque
- Gear system
- Brake system
- Light system
- Seat position adjusted to the rider
- The following components were assembled and checked separately:

-
- The assembling/inspecting party completed a test ride
 - The customer was instructed on how to use the bicycle
 - Left brake lever operates front brake
 - Right brake lever operates front brake

Supplied by (retailer stamp):

Date

Signature assembling party/reailer



If the bicycle with which this instruction manual was issued has only been pre-assembled the enclosed assembly instructions must be read and followed. The checks and limitations mentioned above must be carried out and applied by the owner.

The following operating manuals were supplied and explained:

Bicycle

Plus:

- Gear system Belt drive
- Brake system
- Other documentation:

Unless otherwise specified, trailers, child seats and racks are not permitted, and the bicycle is not licenced for competitions.

Permitted for trailers Yes No

Permitted for child seats Yes No

Permitted for luggage carriers Yes No

Permitted for competitions Yes No

The permitted weight of the rider including luggage is 100 kg. The maximum total weight (weight of the bicycle + rider + baggage + trailer) should not exceed 120 kg.

Differing from this, a maximum permissible total weight of _____ kg applies (weight of the bicycle + rider + baggage + trailer).

If no other weight is specified on the line above, the aforementioned weight of 100 kg for the rider including baggage and 120 kg maximum total weight apply.

Customer/recipient/owner

Name _____

Address _____

Postal code, Town/City _____

e-mail _____

Date of purchase

Recipient's signature/owner

DARE

D

Bicycle identification

Bicycle manufacturer _____

Brand _____

Model _____

Frame height/size _____

Colour _____

Frame number _____

Fork _____

Serial number _____

Rear shock absorber _____

Serial number _____

Gear system _____

Special features _____

In the case of change of ownership:

Owner _____

Address _____

Date/Signature _____



Line up this edge when copying

Please unfold!

Please note the bicycle identification
and handover documentation!

DARE

*Built with advanced technologies and the finest quality,
DARE Bikes promises you a fearless ride.*



DARE-BIKES.COM

